











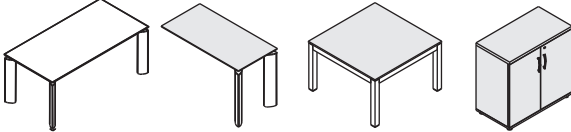

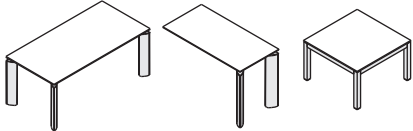

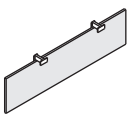

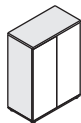







CENNIK
MEBLE GABINETOWE
v.1.0 - 2013

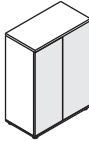

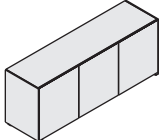
» CRYSTAL - PŁYTA MELAMINOWANA

					
31-DĄB KANADYJSKI	34-KASZTAN	67-BIAŁY PASTEL			
					
15-METAL BIAŁY POŁYSK	08-METAL CZARNY				
					
67-BIAŁY PASTEL	08-CZARNY				
			 FRONT HPL: 101-CZARNY POŁYSK WIENIEC GÓRNY I KORPUS: 08-CZARNY		
67-BIAŁY PASTEL					
			FRONT I WIENIEC GÓRNY HPL: 73-BIAŁY POŁYSK KORPUS: 67-BIAŁY PASTEL		
			FRONT I WIENIEC GÓRNY HPL: 101-CZARNY POŁYSK KORPUS: 08-CZARNY		
					
72-ZIELONY POŁYSK	73-BIAŁY POŁYSK	74-POMARAŃCZOWY POŁYSK	82-CZERWONY POŁYSK	101-CZARNY POŁYSK	
					
31-DĄB KANADYJSKI	34-KASZTAN				

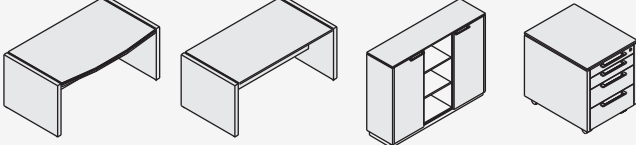
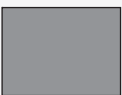
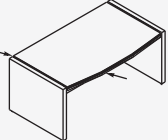
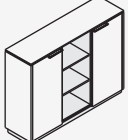
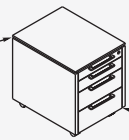
» STATUS

			
31-DĄB KANADYJSKI	34-KASZTAN	106-ORZECH NIZINNY	
			
01-ANTRACYT			

» QUANDO

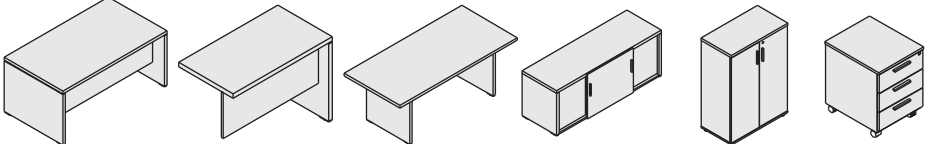
		
34-KASZTAN	106-ORZECH NIZINNY	

» MITO



111-PLATAN JASNY 112-PLATAN CIEMNY

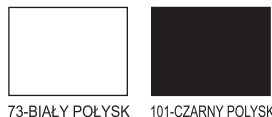
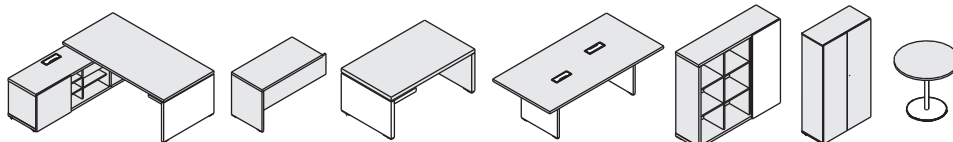

73-BIAŁY POŁYSK 101-CZARNY POŁYSK

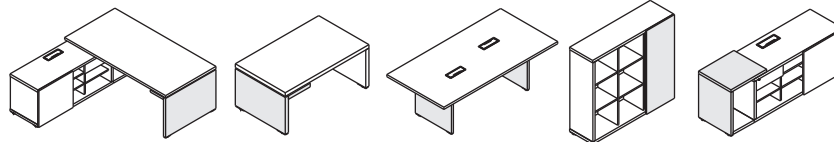

67-BIAŁY PASTEL



FRONT I WIENIEC GÓRNY
HPL:
73-BIAŁY POŁYSK
KORPUS:
67-BIAŁY PASTEL



» IMPULS - SZKŁO



117-SZKŁO BIAŁE 116-SZKŁO CZARNE

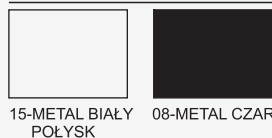
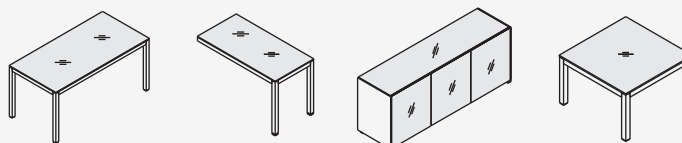

15-METAL BIAŁY POŁYSK 08-METAL CZARNY

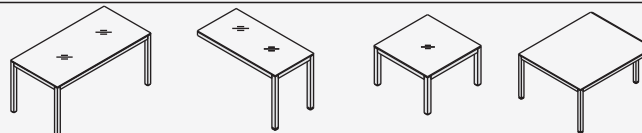

67-BIAŁY PASTEL 08-CZARNY

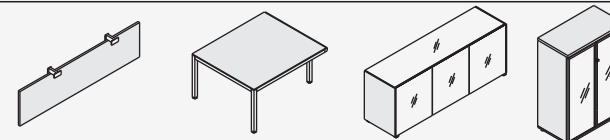

67-BIAŁY PASTEL 101-CZARNY POŁYSK



FRONT I WIENIEC GÓRNY
HPL:
73-BIAŁY POŁYSK
KORPUS:
67-BIAŁY PASTEL

FRONT I WIENIEC GÓRNY
HPL:
101-CZARNY POŁYSK
KORPUS:
08-CZARNY



101-CZARNY POŁYSK



FRONT HPL:
101-CZARNY POŁYSK
WIENIEC GÓRNY I KORPUS:
08-CZARNY



72-ZIELONY POŁYSK 73-BIAŁY POŁYSK 74-POMARAŃCZOWY POŁYSK 82-CZERWONY POŁYSK 101-CZARNY POŁYSK

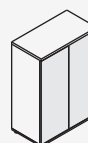

67-BIAŁY PASTEL

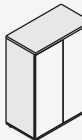

» IMPULS - PŁYTA MELAMINOWANA

			<p>FRONT WIENIEC GÓRNY HPL: 73-BIAŁY POŁYSK KORPUS: 67-BIAŁY PASTEL</p>	<p>FRONT I WIENIEC GÓRNY HPL: 101-CZARNY POŁYSK KORPUS: 08-CZARNY</p>		<p>FRONT HPL: 101-CZARNY POŁYSK WIENIEC GÓRNY I KORPUS: 08-CZARNY</p>

» CRYSTAL - SZKŁO

			<p>FRONT WIENIEC GÓRNY HPL: 73-BIAŁY POŁYSK KORPUS: 67-BIAŁY PASTEL</p>	<p>FRONT I WIENIEC GÓRNY HPL: 101-CZARNY POŁYSK KORPUS: 08-CZARNY</p>		<p>FRONT HPL: 101-CZARNY POŁYSK WIENIEC GÓRNY I KORPUS: 08-CZARNY</p>

MEBLE GABINETOWE

Mito	6
Impuls	12
Crystal	26
Status	36
Quando	43

OPIS TECHNICZNY

Zastosowane materiały:

- HPL
- płyta melaminowana wykonana w technologii struktury synchronicznej 3D, imitująca wygląd i fakturę prawdziwego drewna. Struktura widoczna, wyczuwalna w dotyku.

BIURKO

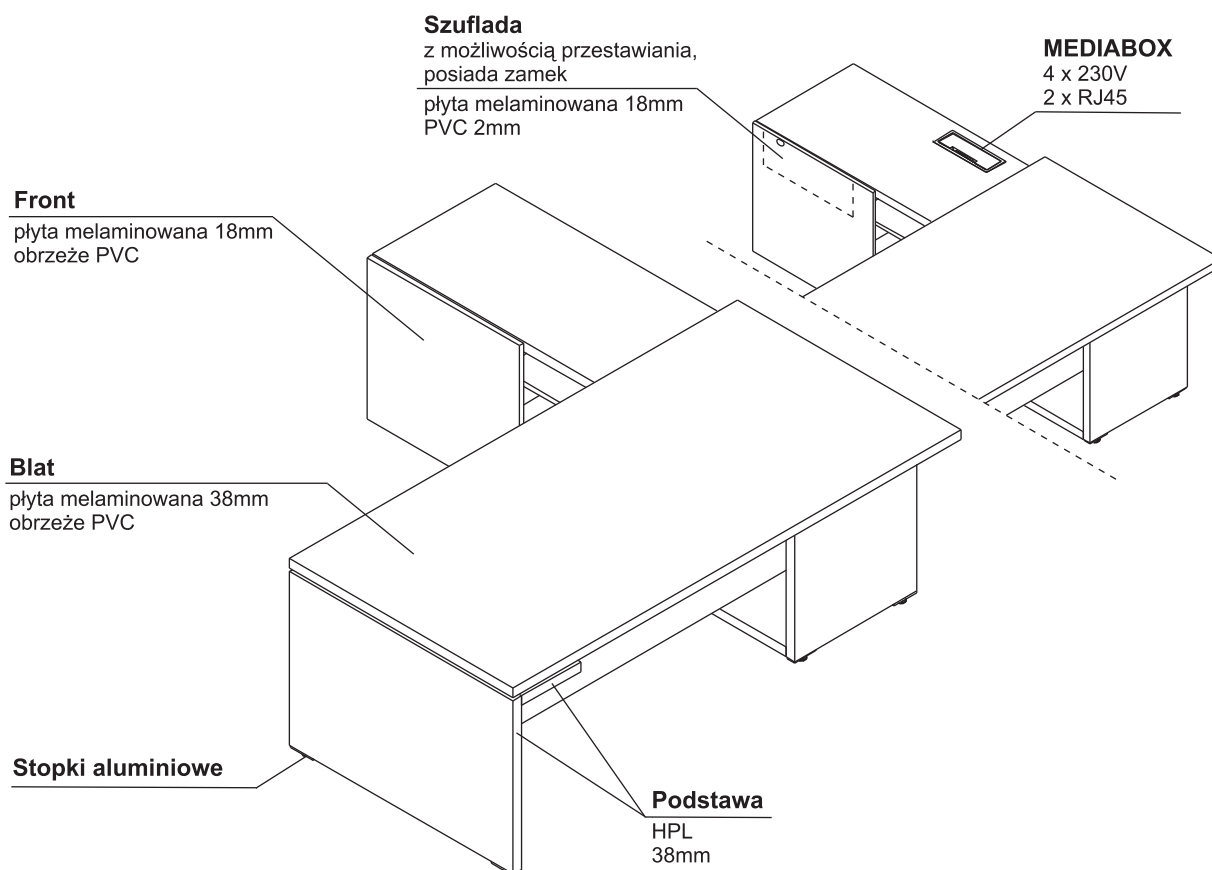

SZAFY

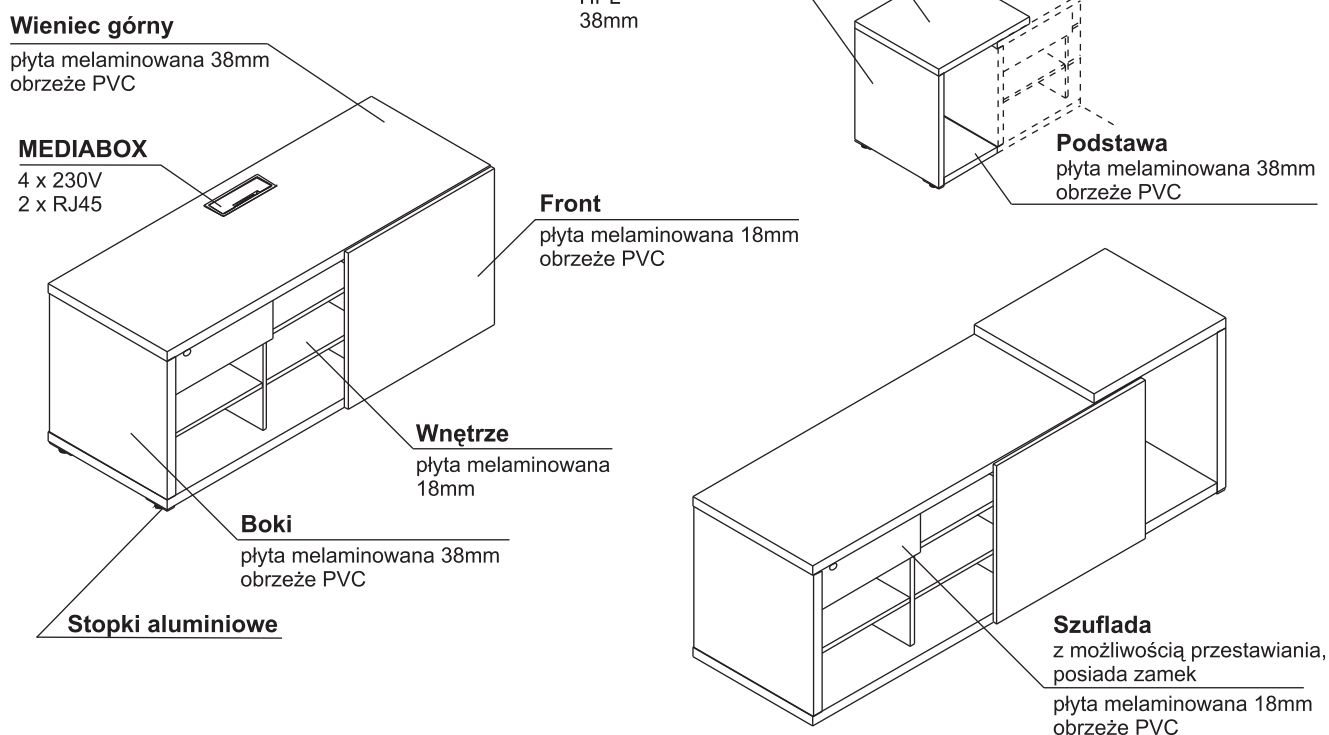

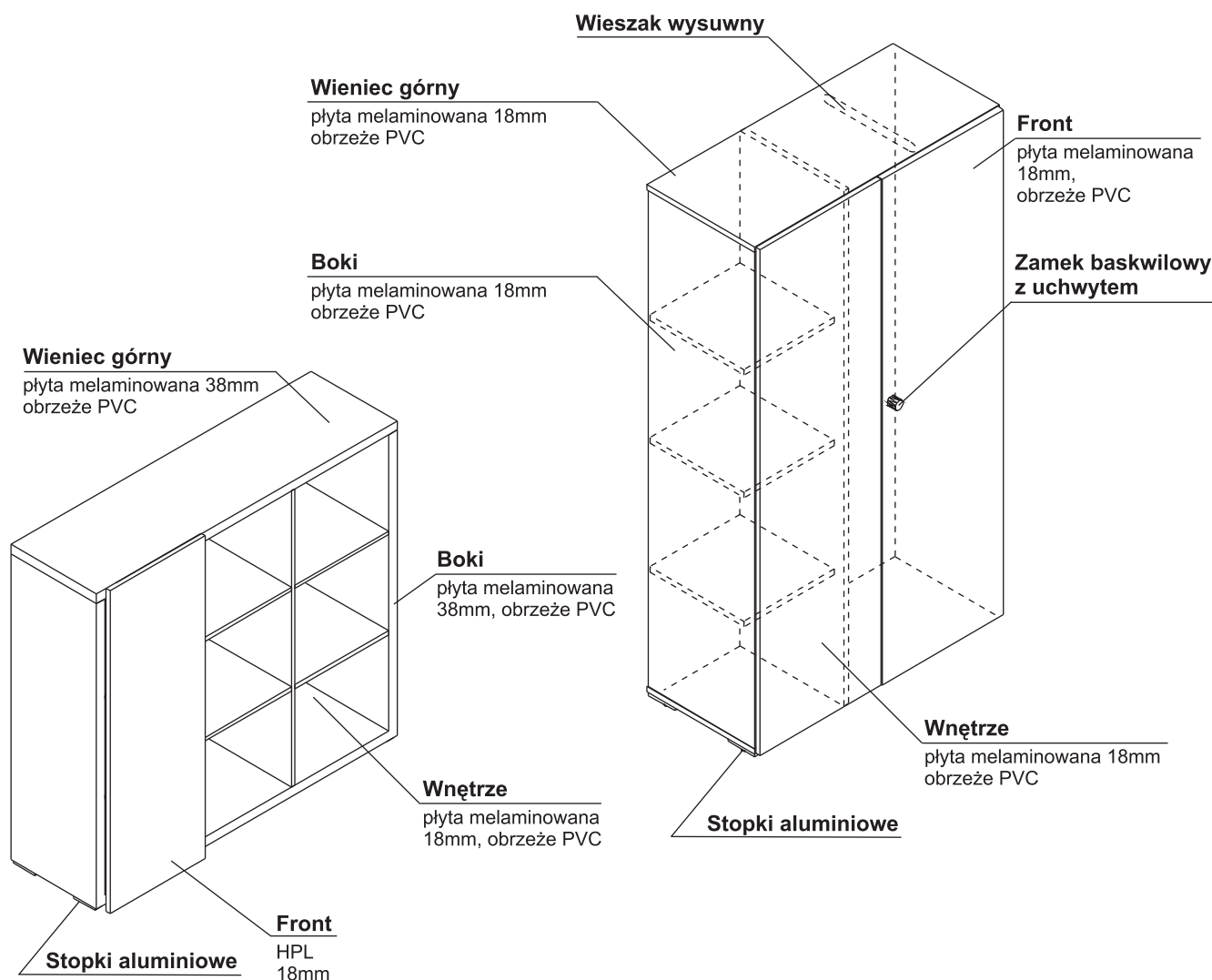
**OPIS TECHNICZNY
SZAFKA**

KONTENER
Zastosowane materiały:

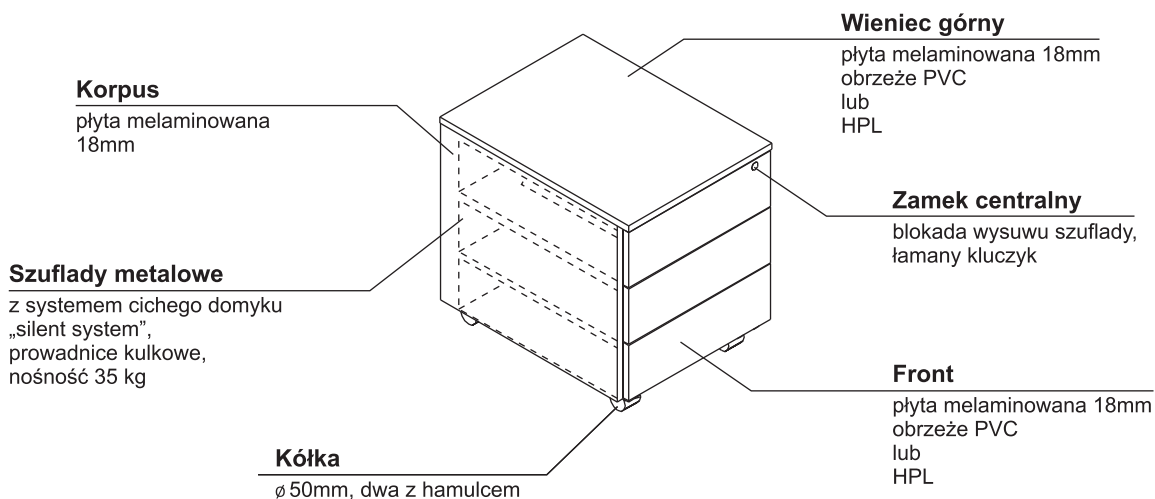
- płyta melaminowana w kolorze białym matowym, HPL - biały połysk



**OPIS TECHNICZNY
STÓŁ, STOLIKI**

Blat

plyta melaminowana 38mm
obrzeże PVC

Stopki aluminiowe

Noga

plyta melaminowana 38mm
obrzeże PVC

Podstawa

HPL
38mm

Blat

plyta melaminowana 38mm
obrzeże PVC

Noga

talerz, kolumna - stal nierdzewna,
malowana proszkowo,
biały połysk

Blat

plyta melaminowana 38mm
obrzeże PVC

Podstawa (nogi+blenda)

HPL
38mm

Stopki aluminiowe

KOLORYSTYKA

BLATY BIUREK I STOLIKÓW,
PRZYSTAWKI,
KORPUSY SZAF,

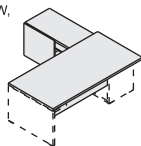

111-PLATAN JASNY
112-PLATAN CIEMNY

LAMINAT HPL:
PANELE BOCZNE BIUREK,
STOŁÓW,
FRONT SZAF

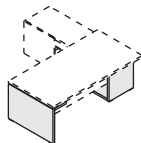

73-BIAŁY POŁYSK
101-CZARNY POŁYSK

KONTENER
SLK13



67-BIAŁY PASTEL

KONTENER HPL
SLK13HT



FRONT I WIENIEC GÓRNY HPL:
73-BIAŁY POŁYSK
KORPUS:
67-BIAŁY PASTEL

WIDOK I RZUT OBIEKTU	WYMIARY (mm)			SYMBOL	CENA NETTO PLN	UWAGI
	Szerokość a / a'	Głębokość b / b'	Wysokość h			

BIURKA Z SZAFKĄ MANAGERSKĄ

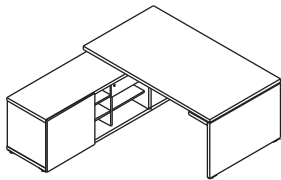
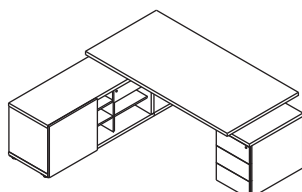
	2000 / 2278	2080	740	MIT1	6 300,-	- szuflada z zamkiem
	1800 / 2078	2080	740	MIT2	6 200,-	- szuflada z zamkiem
	2235 / 2513	2080	740	MIT1K	7 300,-	- szuflada z zamkiem
	2035 / 2313	2080	740	MIT2K	7 200,-	- szuflada z zamkiem

BIURKA Z SZAFKĄ MANAGERSKĄ I MEDIABOXEM

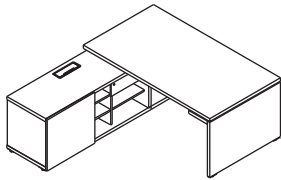
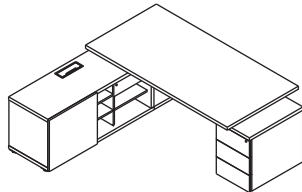
	2000 / 2278	2080	740	MIT1M	6 785,-	- szuflada z zamkiem
	1800 / 2078	2080	740	MIT2M	6 685,-	- szuflada z zamkiem
	2235 / 2513	2080	740	MIT1KM	7 785,-	- szuflada z zamkiem
	2035 / 2313	2080	740	MIT2KM	7 685,-	- szuflada z zamkiem

BIURKO

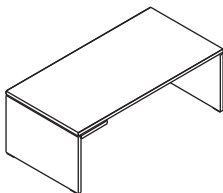
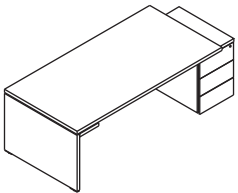
	2000	1000	740	MIT3	2 600,-	
	1800	1000	740	MIT4	2 500,-	
	2513	1000	740	MIT3K	3 600,-	
	2313	1000	740	MIT4K	3 500,-	

WIDOK I RZUT OBIEKTU	WYMIARY (mm)			SYMBOL	CENA NETTO PLN	UWAGI
	Szerokość a / a'	Głębokość b / b'	Wysokość h			

PRZYSTAWKA

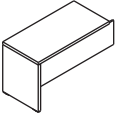
	1200	600	740	MIT12	1 300,-	
---	------	-----	-----	--------------	---------	--

KONTENER

	470	616	580	SLK13	745,-	
---	-----	-----	-----	--------------	-------	--

KONTENER Z WIEŃCEM GÓRNYM I FRONTEM HPL

	470	616	580	SLK13HT	1 600,-	
---	-----	-----	-----	----------------	---------	--

PODKŁADKA NA BIURKO

	700	500	-	S100	1 025,-	- skóra czarna
--	-----	-----	---	-------------	---------	----------------

SZAFY

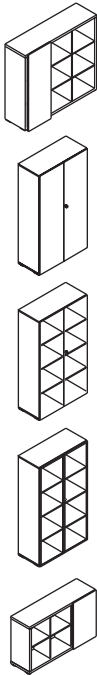
	1400	420	1280	MIT7	3 700,-	
	916	418	1659	MIT8	2 645,-	- szafa ubraniowa
	916	418	1659	MIT15	3 200,-	- szafa aktowa
	916	420	1659	MIT16	3 600,-	- witryna, szkło bezbarwne, ramka aluminiowa
	1400	420	722	MIT18	2 700,-	

SZAFKA MANAGERSKA

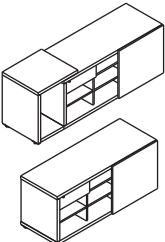
	1887	572	690	MIT5	4 330,-	- szafka z dostawką, szuflada z zamkiem
	1500	572	652	MIT6	3 220,-	- szuflada z zamkiem

WIDOK I RZUT OBIEKTU	WYMIARY (mm)			SYMBOL	CENA NETTO PLN	UWAGI
	Szerokość a / a'	Głębokość b / b'	Wysokość h			

SZAFKA MANAGERSKA Z MEDIABOXEM

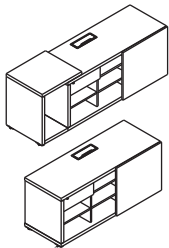
	1887	572	690	MIT5M	4 815,-	- szafka z dostawką, szuflada z zamkiem
	1500	572	652	MIT6M	3 710,-	- szuflada z zamkiem

STOLIK I STOŁY KONFERENCYJNE

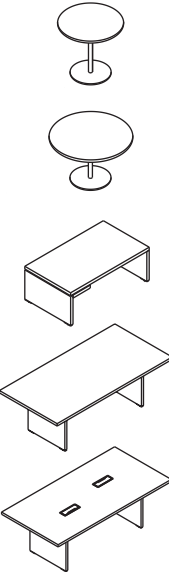
	∅ 800	-	740	MIT10	1 035,-	
	∅ 1200	-	740	MIT17	1 450,-	- talerz - stal nierdzewna, 09-aluminium - kolumna - malowana proszkowo, 15-biały, 115-czarny
	1000	600	450	MIT9	1 850,-	
	2200	1100	740	MIT11	2 990,-	
	2200	1100	740	MIT11M	4 025,-	MEDIABOX (1szt.) 4 x 230V 2 x RJ45

OPIS TECHNICZNY

Zastosowane materiały:

- szkło satynowane, hartowane ultra clear (dla białego)
- profil aluminiowy anodowany, malowany proszkowo, z detalami chromowanymi

BIURKO, PRZYSTAWKA, STOLIKI, STÓŁ

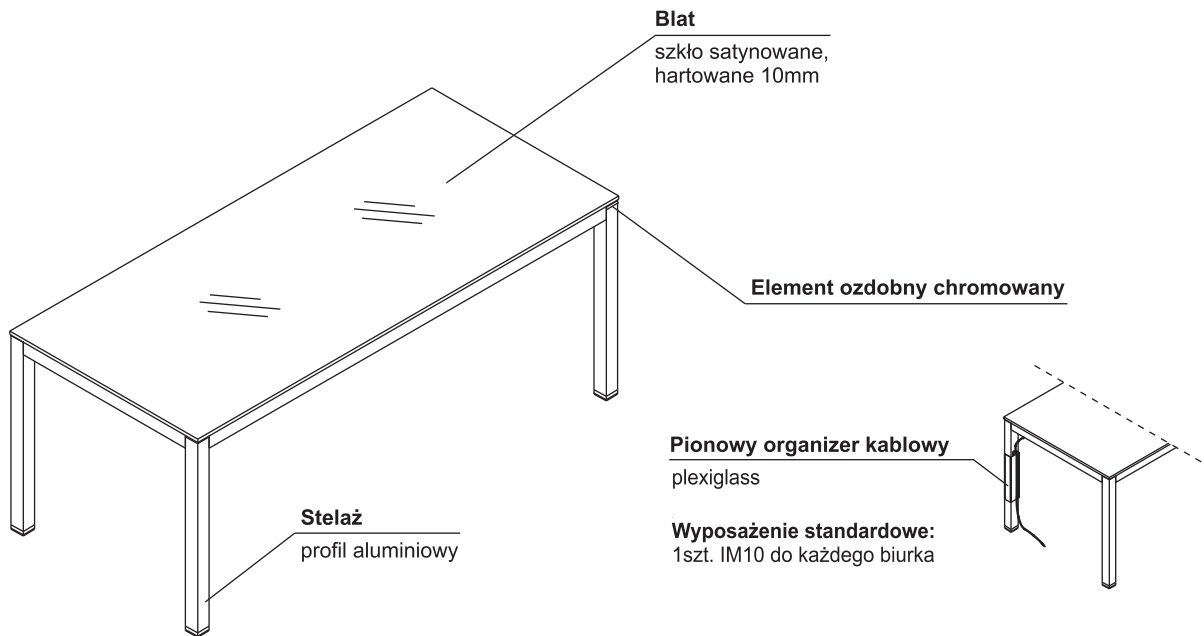

BLENDY, PRZYSTAWKA

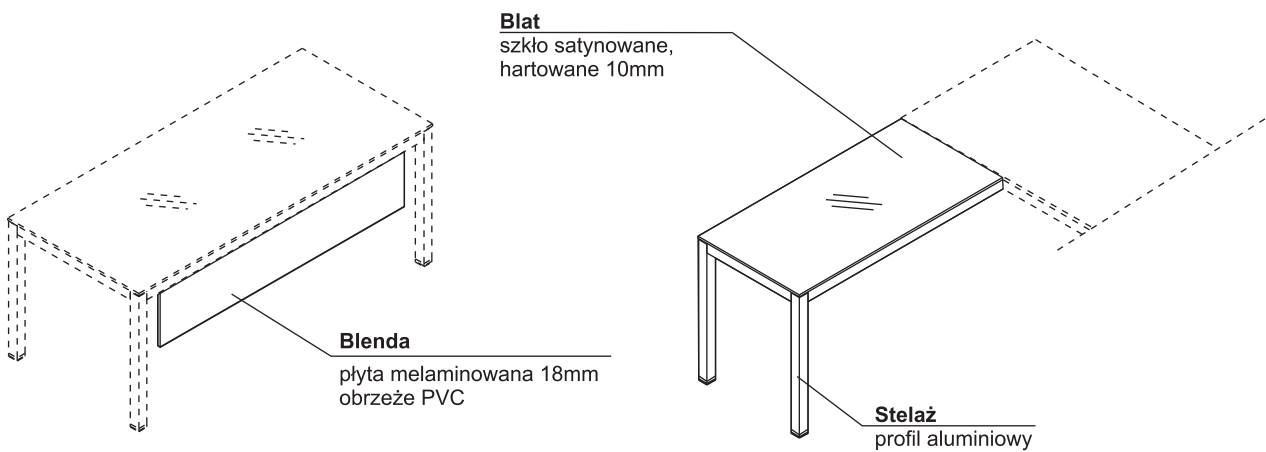

STÓŁ KONFERENCYJNY

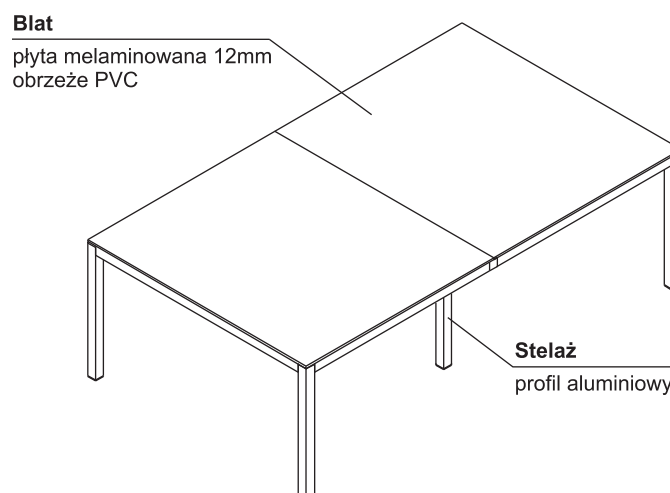

OPIS TECHNICZNY
SZAFY

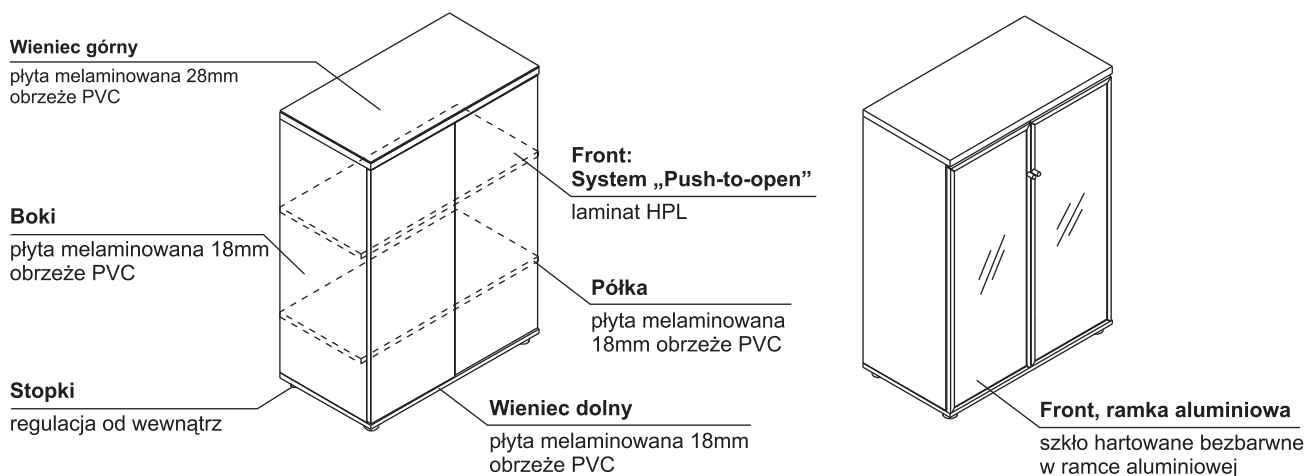

KOMODA ZE SZKŁEM

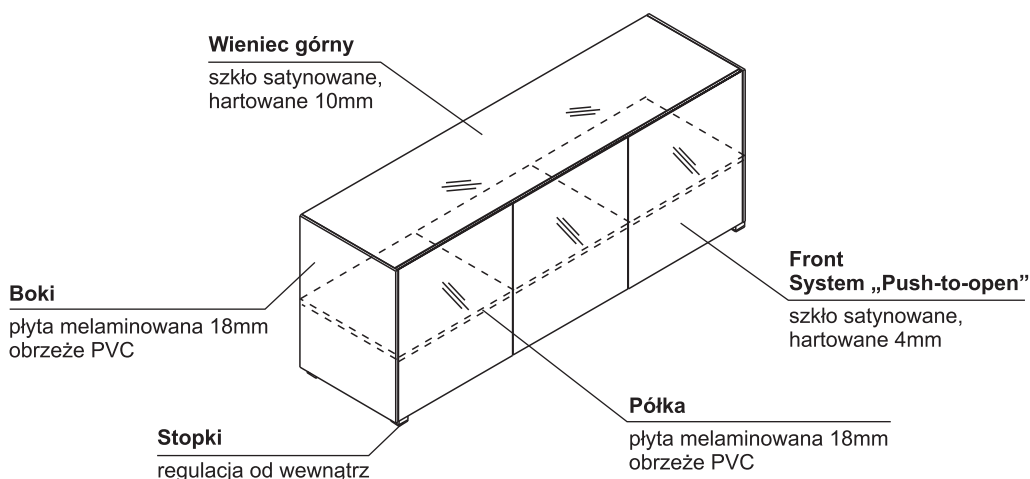

KONTENER SLK13HT

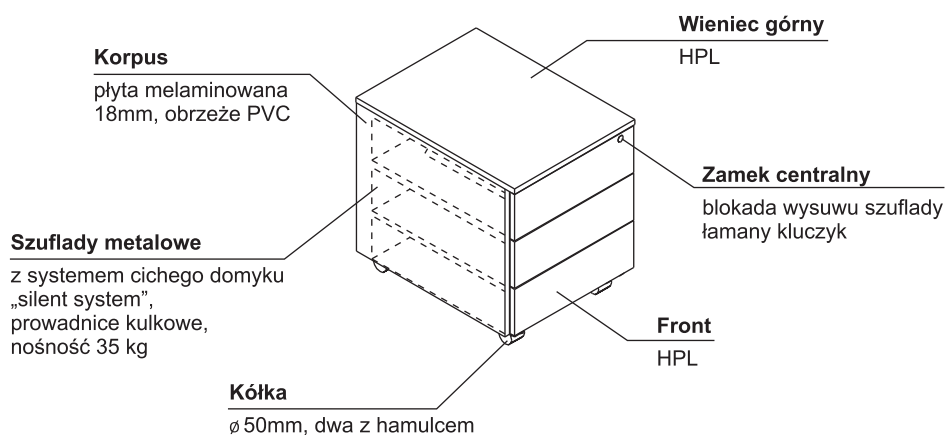

KOLORYSTYKA

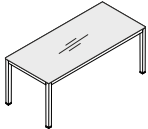
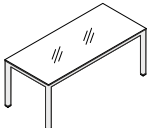
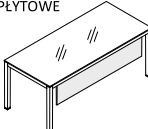
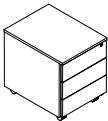
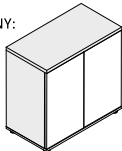
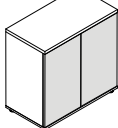
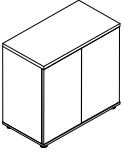
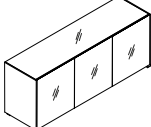
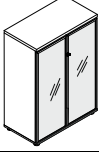
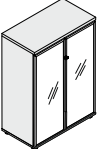
<p>BLATY SZKLANE</p> 	<p>117 – SZKŁO BIAŁE 116 – SZKŁO CZARNE</p>	
<p>STELAŻ</p> 	<p>15 – METAL BIAŁY POŁYSK 08 – METAL CZARNY</p>	
<p>OSŁONA, BLATY PŁYTOWE</p> 	<p>67 – BIAŁY PASTEL 08 – CZARNY</p>	
<p>KONTENER HPL SLK13HT</p> 	<p>FRONT I WIENIEC GÓRNY HPL: 73 - BIAŁY POŁYSK</p> <p>KORPUS: 67 - BIAŁY PASTEL</p>	<p>FRONT I WIENIEC GÓRNY HPL: 101 - CZARNY POŁYSK</p> <p>WIENIEC GÓRNY I KORPUS: 08 - CZARNY</p>
<p>SZAFA Z FRONTEM HPL KORPUS I WIENIEC GÓRNY:</p> 	<p>SZAFA Z FRONTEM HPL FRONT:</p>  <p>67 – BIAŁY PASTEL</p>	<p>72 - ZIELONY POŁYSK 82 - CZERWONY POŁYSK 73 - BIAŁY POŁYSK</p> <p>74 - POMARAŃCZOWY POŁYSK 101 - CZARNY POŁYSK</p>
<p>SZAFA Z FRONTEM HPL</p> 	<p>FRONT - HPL: 101 - CZARNY POŁYSK</p> <p>WIENIEC GÓRNY I KORPUS: 08 - CZARNY</p>	
<p>KOMODA ZE SZKŁEM</p> 	<p>FRONT: 117 - SZKŁO BIAŁE</p> <p>WIENIEC GÓRNY I KORPUS: 67 - BIAŁY PASTEL</p>	<p>FRONT: 116 - SZKŁO CZARNE</p> <p>WIENIEC GÓRNY I KORPUS: 08 - CZARNY</p>
<p>FRONT SZKŁO</p> 	<p>SO – SZKŁO BEZBARWNE</p>	
<p>WIENIEC GÓRNY I KORPUS</p> 	<p>67 – BIAŁY PASTEL 08 – CZARNY</p>	

WIDOK I RZUT OBIEKTU	WYMIARY (mm)			SYMBOL	CENA NETTO PLN	UWAGI
	Szerokość a / a'	Głębokość b / b'	Wysokość h			

BIURKA Z BLATEM SZKLANYM

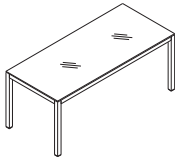
	1600	800	760	IM04S	4 200,-	
	1800	900	760	IM05S	4 500,-	
	2000	900	760	IM06S	4 800,-	

OSŁONY PŁYTOWE DO BIUREK

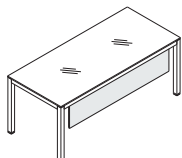
	1400	18	350	IM04B	270,-	
	1600	18	350	IM05B	330,-	
	1800	18	350	IM06B	400,-	

PRZYSTAWKA DO BIURKA Z BLATEM SZKLANYM

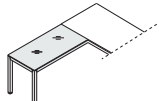
	1200	600	760	IM07S	2 400,-	
---	------	-----	-----	--------------	---------	--

KONTENER MOBILNY Z WIĘNCEM GÓRNYM I FRONTEM HPL

	470	616	580	SLK13HT	1 600,-	- płyta melaminowana Front i wieniec górny HPL
---	-----	-----	-----	----------------	---------	---

KOMODA ZE SZKŁEM

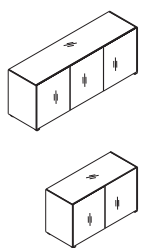
	2000	432	740	IM20S	5 000,-	- wieniec górny i drzwi szkło
	1334	432	740	IM21S	4 100,-	- wieniec górny i drzwi szkło

STOLIKI Z BLATEM SZKLANYM

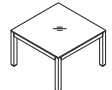

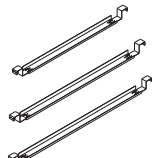

	800	800	500	IM57S	2 500,-	
---	-----	-----	-----	--------------	---------	--

KANAŁY KABLOWE



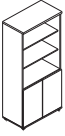

	1496	85	94	EK1200	450,-	- do biurka 1600mm
	1696	85	94	EK1400	465,-	- do biurka 1800mm
	1896	85	94	EK1600	485,-	- do biurka 2000mm

WIDOK I RZUT OBIEKTU	WYMIARY (mm)			SYMBOL	I GRUPA (korpus: 26-alum. sat.)	II GRUPA (szafa cała w kolorze)
	Szerokość a / a'	Głębokość b / b'	Wysokość h			

SZAFY Z FRONTEM HPL

 	802	432	1833	A5104H	-	1 690,-
 	802	432	1833	A5404H	-	1 070,-
 	802	432	1129	A3104H	-	1 135,-
 	802	432	1129	A3404H	-	920,-
 	802	432	777	A2104H	-	835,-

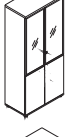
WITRYNY

- drzwi szklane w ramce aluminiowej  	802	432	1833	A5104W	-	1 765,-
- drzwi szklane w ramce aluminiowej - drzwi płytowe: system „Push-to-open” z frontem HPL  	802	432	1833	A5404W	-	1 530,-
- drzwi szklane w ramce aluminiowej  	802	432	1129	A3104W	-	1 135,-



Szafy nie posiadają zamka.

WIDOK I RZUT OBIEKTU	WYMIARY (mm)			SYMBOL	CENA NETTO PLN	UWAGI
	Szerokość a / a'	Głębokość b / b'	Wysokość h			

STÓŁ MODUŁOWY

	1200	1400	760	IM53	1 900,-	- element początkowy
	1200	1400	760	IM54	1 600,-	- element środkowy
	1200	1400	760	IM55	1 750,-	- element końcowy

PRZYKŁADY ARANŻACJI

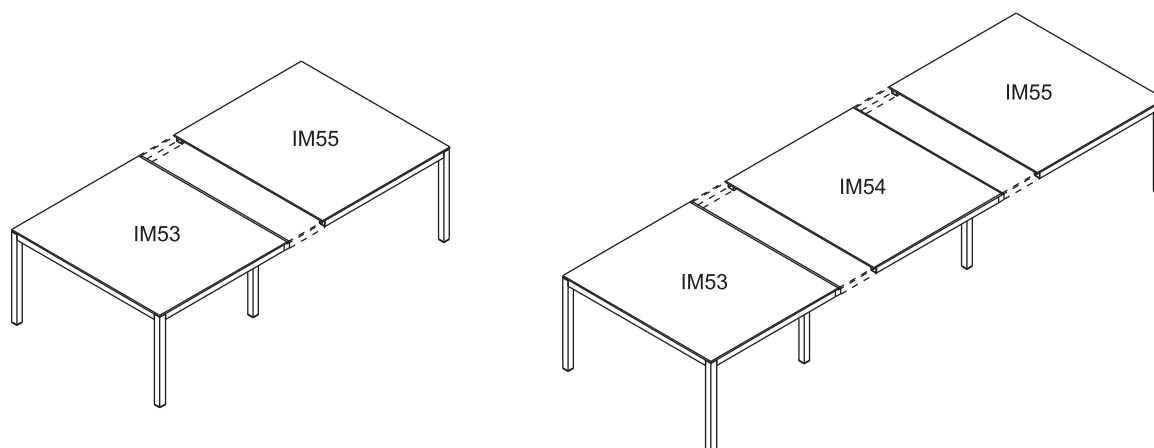

ELEMENTY DODATKOWE

	300	110	110	M01	485,-	- 4 x 230V - 2 x RJ45 104-szary struktura - wyłącznie do blatów płytowych
	-	-	350	IM10	50,-	- pionowy organizator kablowy, pleksiglas bezbarwny

KONFIGURACJA MEDIABOX M01: STOŁY MODUŁOWE



- możliwość usytuowania w jednym miejscu (M)
- opcję należy dopisać na końcu symbolu oraz doliczyć wartość mediabox M01 do ceny biurka:
np.

$$\text{IM53M} = 1\,900\text{zł} + 485\text{zł} = 2\,385\text{zł}$$

OPIS TECHNICZNY

Zastosowane materiały:

- płyta melaminowana
- profil aluminiowy anodowany, malowany proszkowo, z detalami chromowanymi

BIURKO, PRZYSTAWKA, STOLIKI, STÓŁ

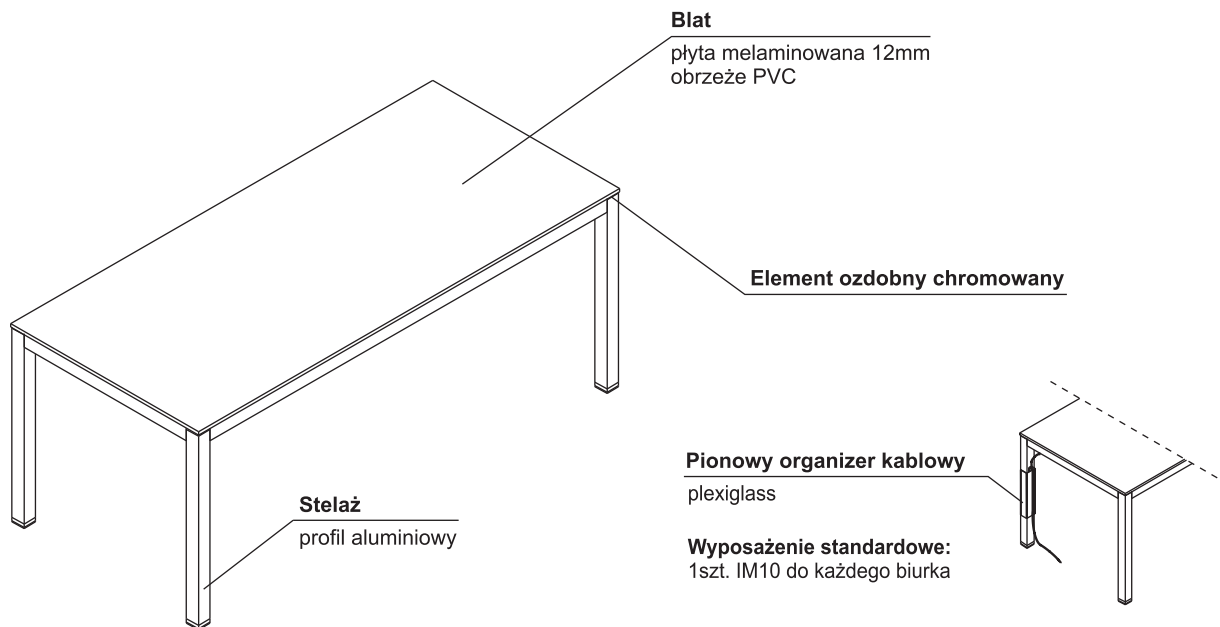

BLENDY, PRZYSTAWKA

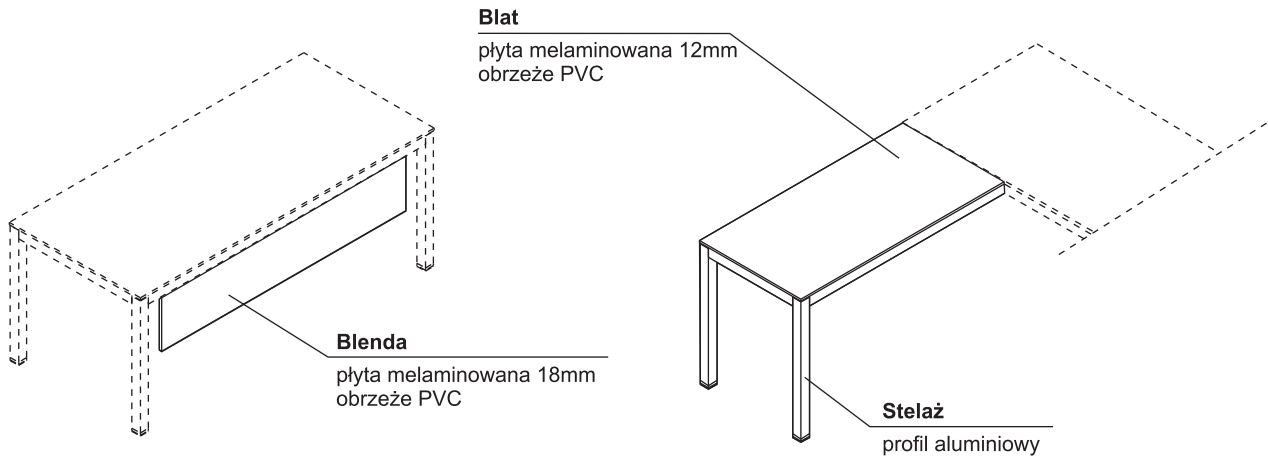

STÓŁ KONFERENCYJNY

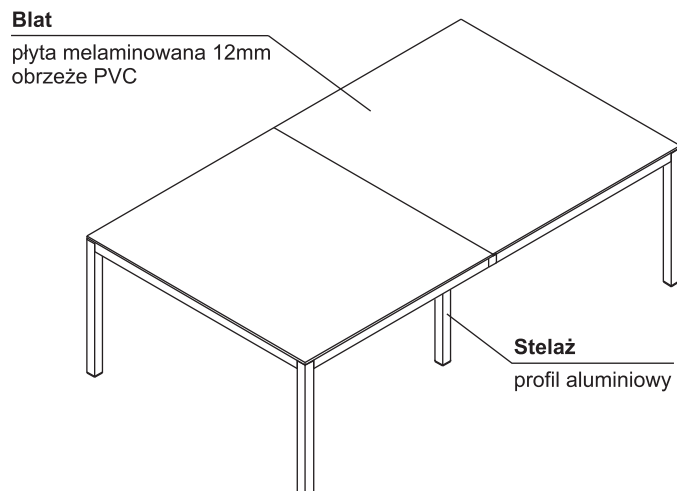

OPIS TECHNICZNY
SZAFY

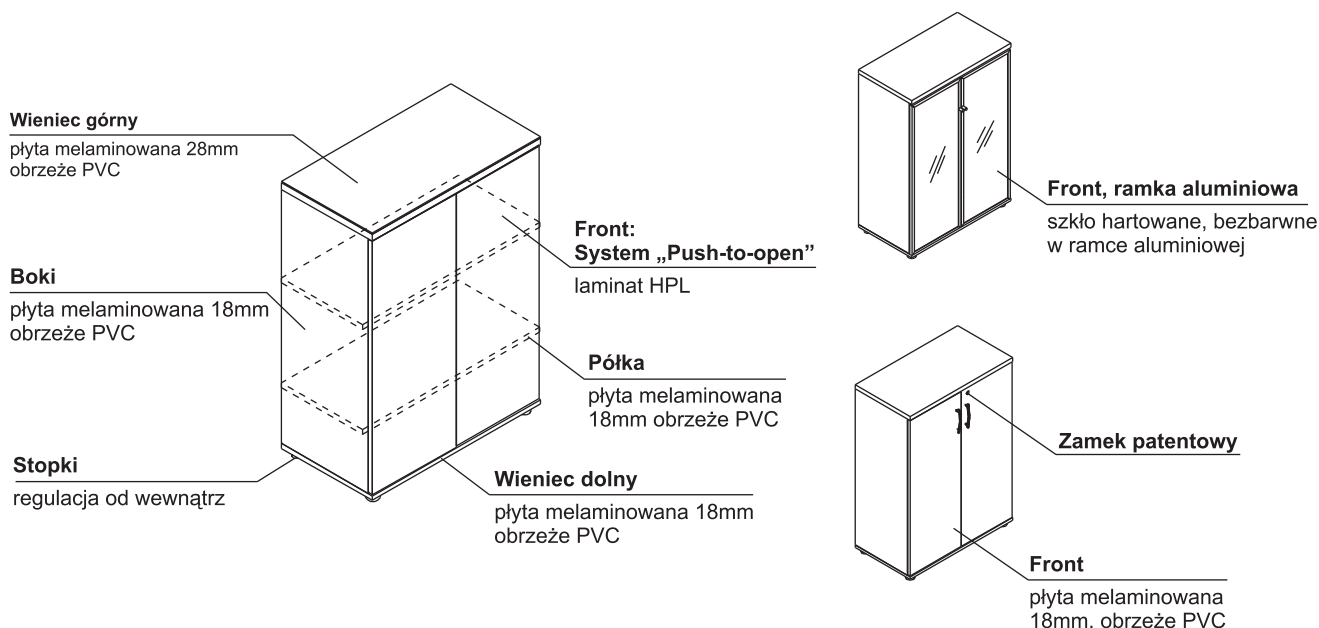

KOMODA, SZAFKA ZS02, ZS03

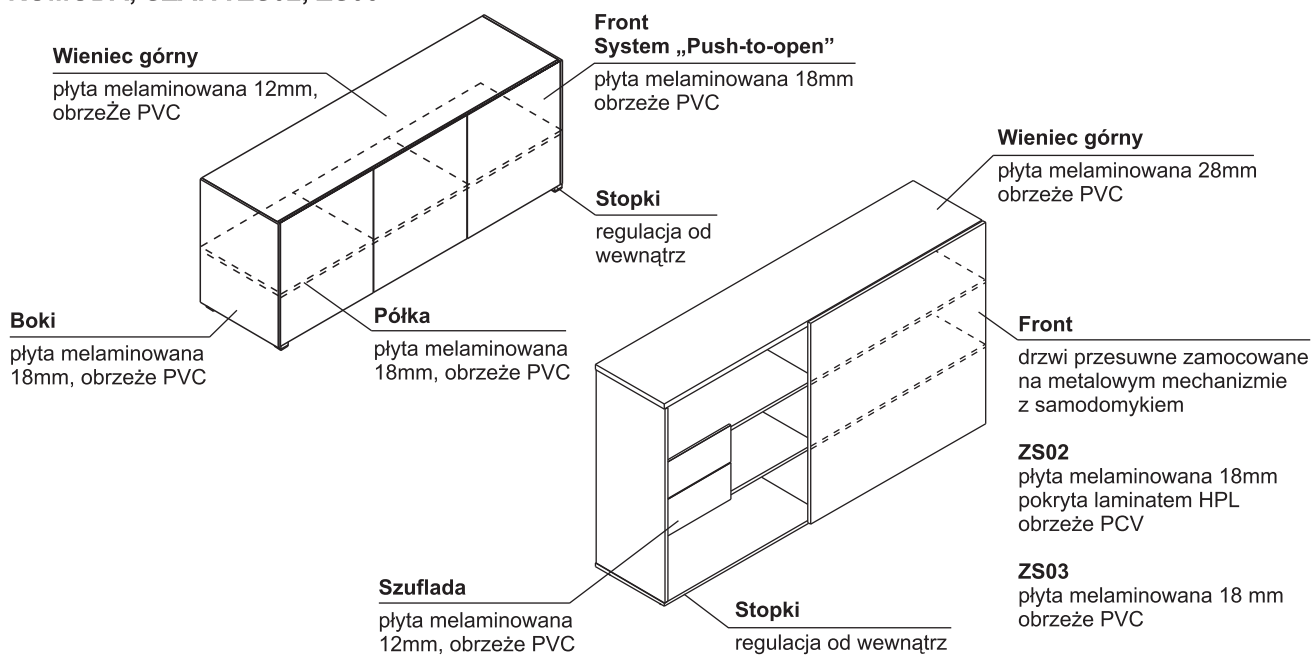

KONTENER SLK13HT

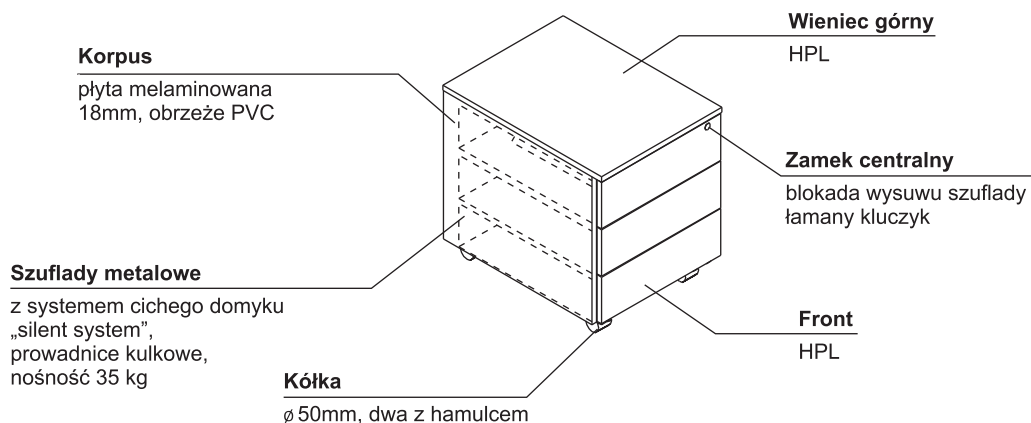

KOLORYSTYKA

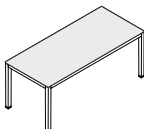
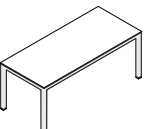
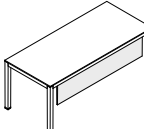
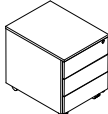
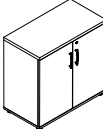
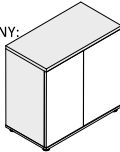
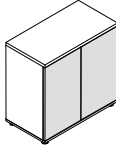
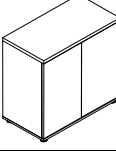
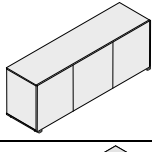
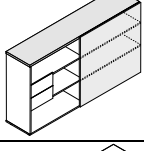
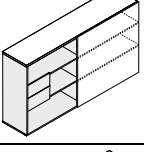
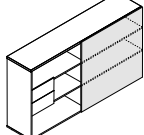
BLAT, PRZYSTAWKA, STOLIK		31 – DĄB KANADYJSKI 34 – KASZTAN 67 – BIAŁY PASTEL
STELAŻ		15 – METAL BIAŁY POŁYSK 08 – METAL CZARNY
OSŁONA		67 – BIAŁY PASTEL 08 – CZARNY
KONTENER HPL SLK13HT		FRONT I WIENIEC GÓRNY HPL: 73 - BIAŁY POŁYSK FRONT I WIENIEC GÓRNY I HPL: 101 - CZARNY POŁYSK KORPUS: 67 - BIAŁY PASTEL KORPUS: 08 - CZARNY
FRONT, WIENIEC GÓRNY I KORPUS		31 – DĄB KANADYJSKI 34 – KASZTAN 67 – BIAŁY PASTEL
SZAFKA Z FRONTEM HPL KORPUS I WIENIEC GÓRNY:		67 – BIAŁY PASTEL
SZAFKA Z FRONTEM HPL FRONT:		72 - ZIELONY POŁYSK 82 - CZERWONY POŁYSK 73 - BIAŁY POŁYSK 101 - CZARNY POŁYSK 74 - POMARAŃCZOWY POŁYSK
SZAFKA Z FRONTEM HPL		FRONT - HPL: 101 - CZARNY POŁYSK WIENIEC GÓRNY I KORPUS: 08 - CZARNY
KOMODA IM20		31 – DĄB KANADYJSKI 34 – KASZTAN
WIENIEC GÓRNY I FRONT – ZS03		31 – DĄB KANADYJSKI 34 – KASZTAN 67 – BIAŁY PASTEL
KORPUS – ZS03		67 – BIAŁY PASTEL
FRONT HPL – ZS02		72 - ZIELONY POŁYSK 73 - BIAŁY POŁYSK 74 - POMARAŃCZOWY POŁYSK 82 - CZERWONY POŁYSK

KOLORYSTYKA

WIENIEC GÓRNY
I KORPUS – ZS02

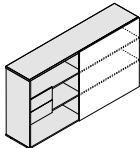

67 – BIAŁY PASTEL

FRONT SZKŁO

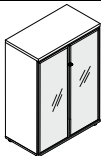

SO – SZKŁO BEZBARWNE

KORPUS

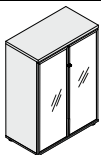

67 – BIAŁY PASTEL

08 – CZARNY

WIDOK I RZUT OBIEKTU	WYMIARY (mm)			SYMBOL	CENA NETTO PLN	UWAGI
	Szerokość a / a'	Głębokość b / b'	Wysokość h			

BIURKA Z BLATEM PŁYTOWYM

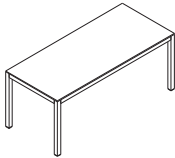
	1600	800	760	IM04	1 900,-	
	1800	900	760	IM05	2 000,-	
	2000	900	760	IM06	2 150,-	

OSŁONY PŁYTOWE DO BIUREK

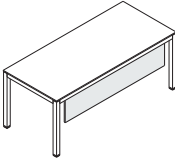
	1400	18	350	IM04B	270,-	
	1600	18	350	IM05B	330,-	
	1800	18	350	IM06B	400,-	

PRZYSTAWKA DO BIURKA Z BLATEM PŁYTOWYM

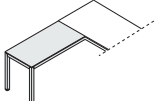
	1200	600	760	IM07	1 250,-	
---	------	-----	-----	-------------	---------	--

KONTENER MOBILNY Z WIĘNCEM GÓRNYM I FRONTEM HPL

	470	616	580	SLK13HT	1 600,-	- płyta melaminowana Front i wieńiec górny HPL
---	-----	-----	-----	----------------	---------	---

STOLIK

	∅ 1200	-	730	ST12	1 250,-	- talerz - stal nierdzewna, 09-alum. - kolumna - malowana proszkowo, 15-biały, 115-czarny, 09-aluminium
---	--------	---	-----	-------------	---------	--

STOLIKI Z BLATEM PŁYTOWYM

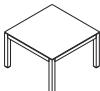
	800	800	500	IM57	1 650,-	
---	-----	-----	-----	-------------	---------	--

KANAŁY KABLOWE

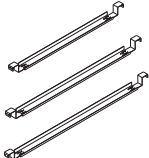





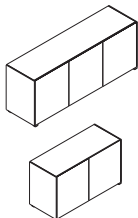

	1496	85	94	EK1200	450,-	- do biurka 1600mm
	1696	85	94	EK1400	465,-	- do biurka 1800mm
	1896	85	94	EK1600	485,-	- do biurka 2000mm

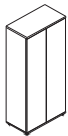
WIDOK I RZUT OBIEKTU	WYMIARY (mm)			SYMBOL	I GRUPA (korpus: 26-alum. sat.)	II GRUPA (szafa cała w kolorze)
	Szerokość a / a'	Głębokość b / b'	Wysokość h			

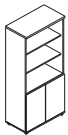



KOMODA

	2000	432	740	IM20	-	3 000,-
	1334	432	740	IM21	-	2 500,-

SZAFY Z FRONTEM HPL

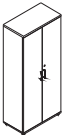
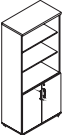
 	802	432	1833	A5104H	-	1 690,-
 	802	432	1833	A5404H	-	1 070,-
 	802	432	1129	A3104H	-	1 135,-
 	802	432	1129	A3404H	-	920,-
 	802	432	777	A2104H	-	835,-

SZAFY Z UCHWYTEM







	802	432	1833	A5104	-	1 065,-
	802	432	1833	A5404	-	965,-
	802	432	1129	A3104	-	780,-
	802	432	1129	A3504	-	540,-
	802	432	777	A2104	-	620,-







Szafy nie posiadają zamka.

WIDOK I RZUT OBIEKTU	WYMIARY (mm)			SYMBOL	I GRUPA (korpus: 26-alum. sat.)	II GRUPA (szafa cała w kolorze)
	Szerokość a / a'	Głębokość b / b'	Wysokość h			

WITRYNY

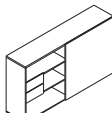
- drzwi szklane w ramce aluminiowej  	802	432	1833	A5104W	-	1 765,-
- drzwi szklane w ramce aluminiowej - drzwi płytowe: system „Push-to-open” z frontem HPL  	802	432	1833	A5404W	-	1 530,-
- drzwi szklane w ramce aluminiowej  	802	432	1129	A3104W	-	1 135,-

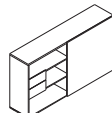
SZAFY Z DRZWIAMI PRZESUWNymi

- front HPL  	2000	434	1129	ZS02	-	2 025,-
- front melamina  	2000	432	1129	ZS03	-	1 705,-
- szuflada do szaf  	428	385	403	ZSZ01	-	280,-



Szafy nie posiadają zamka.

WIDOK I RZUT OBIEKTU	WYMIARY (mm)			SYMBOL	CENA NETTO PLN	UWAGI
	Szerokość a / a'	Głębokość b / b'	Wysokość h			

STÓŁ MODUŁOWY

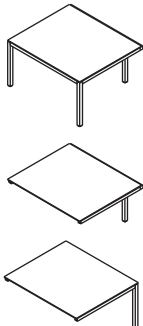
	1200	1400	760	IM53	1 900,-	- element początkowy
	1200	1400	760	IM54	1 600,-	- element środkowy
	1200	1400	760	IM55	1 750,-	- element końcowy

PRZYKŁADY ARANŻACJI

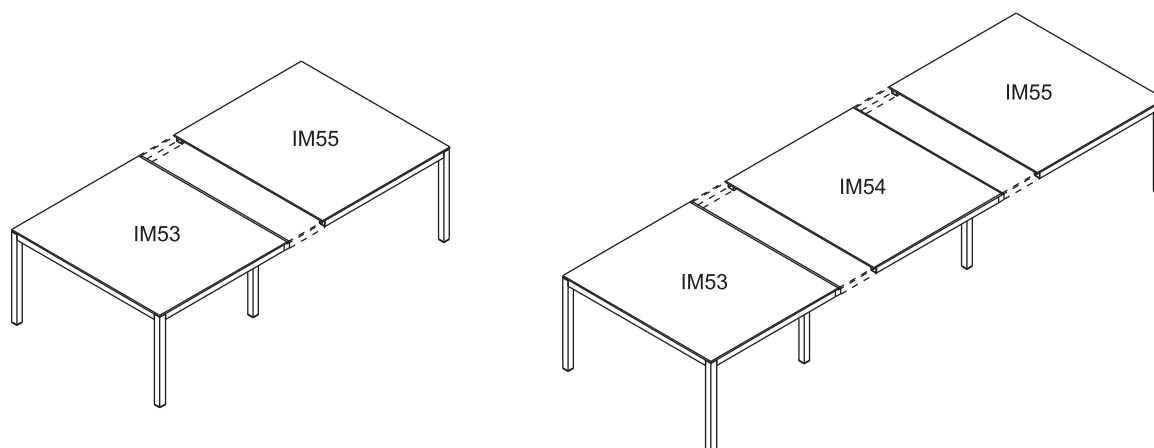

ELEMENTY DODATKOWE

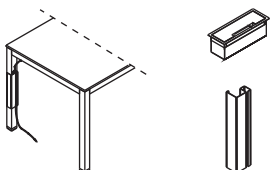
	300	110	110	M01	485,-	- 4 x 230V - 2 x RJ45 104-szary struktura - wyłącznie do blatów płytowych
	-	-	350	IM10	50,-	- pionowy organizator kablowy, pleksiglas bezbarwny

KONFIGURACJA MEDIABOX M01: BIURKA Z BLATEM PŁYTOWYM



- możliwość usytuowania w jednym miejscu (M)
- opcję należy dopisać na końcu symbolu oraz doliczyć wartość mediabox M01 do ceny biurka:
np.

$$IM06M = 1\,980\text{zł} + 485\text{zł} = 2\,465\text{zł}$$

KONFIGURACJA MEDIABOX M01: STOŁY MODUŁOWE



- możliwość usytuowania w jednym miejscu (M)
- opcję należy dopisać na końcu symbolu oraz doliczyć wartość mediabox M01 do ceny biurka:
np.

$$IM53M = 1\,900\text{zł} + 485\text{zł} = 2\,385\text{zł}$$

OPIS TECHNICZNY

Zastosowane materiały:

- szkło satynowane, hartowane, ultra clear (dla białego)
- profil aluminiowy anodowany, malowany proszkowo

BIURKO, STÓŁ KONFERENCYJNY

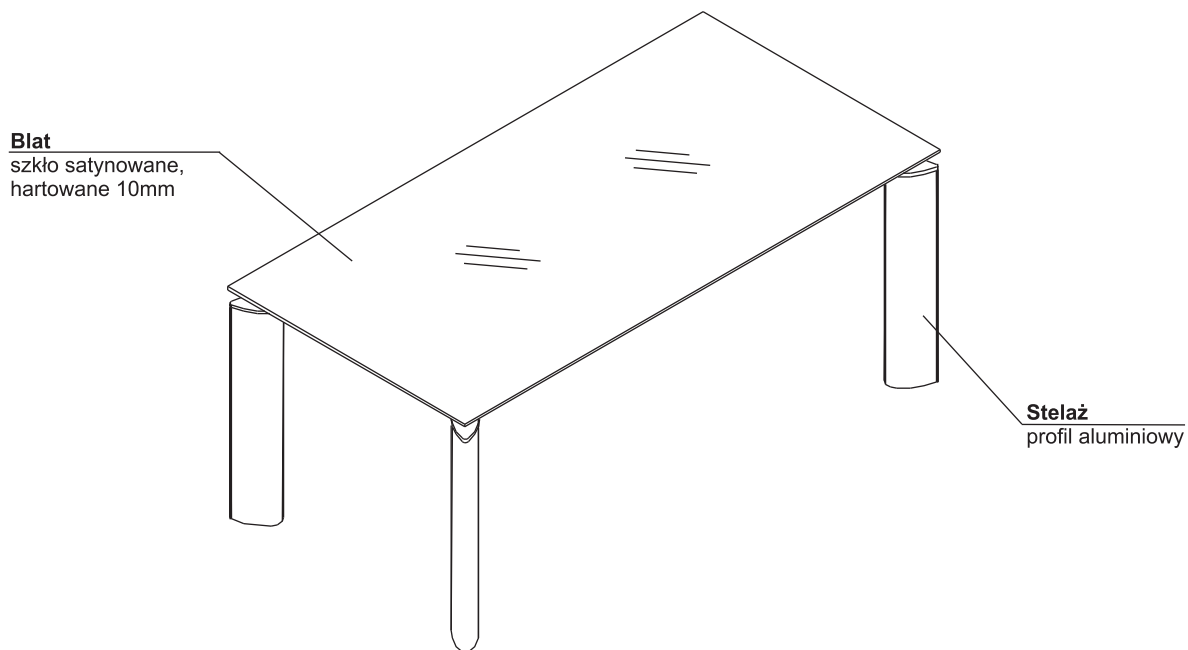

PRYZSTAWKA

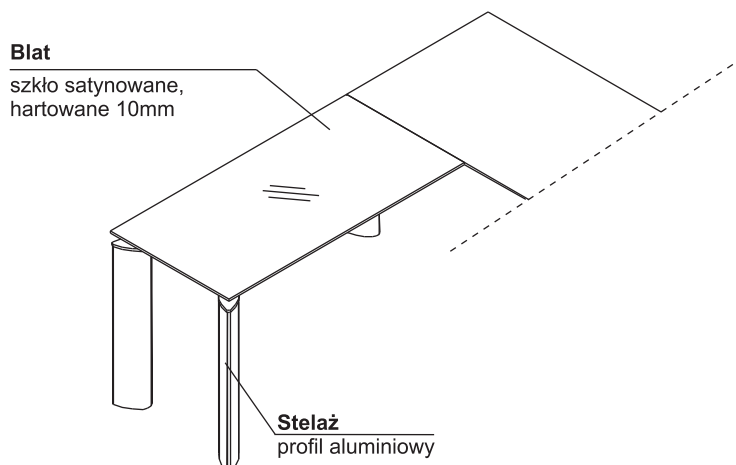

BLENDY

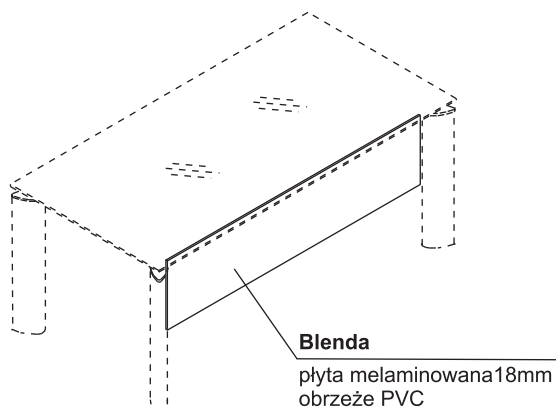

OPIS TECHNICZNY SZAFY

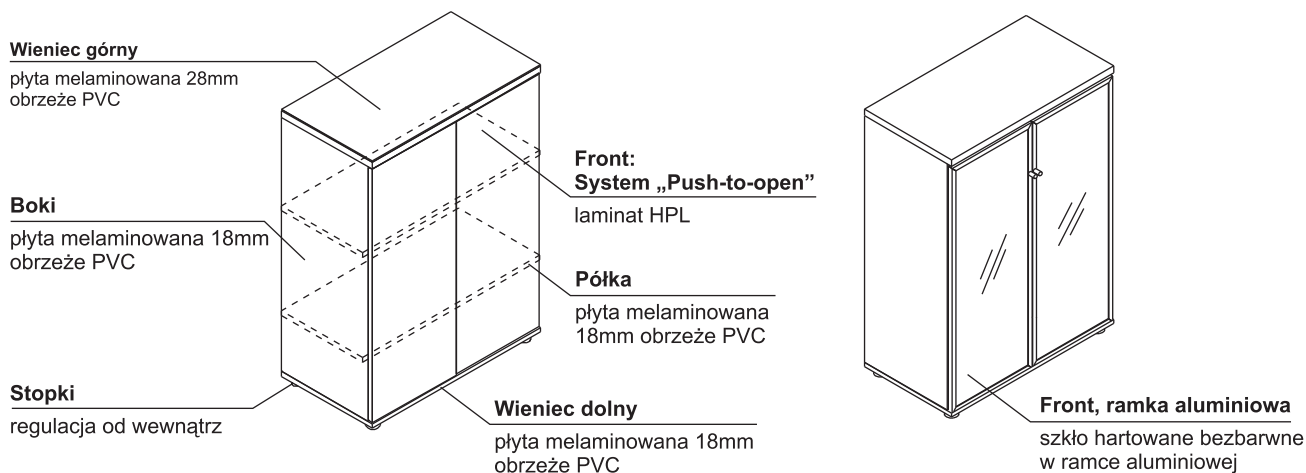

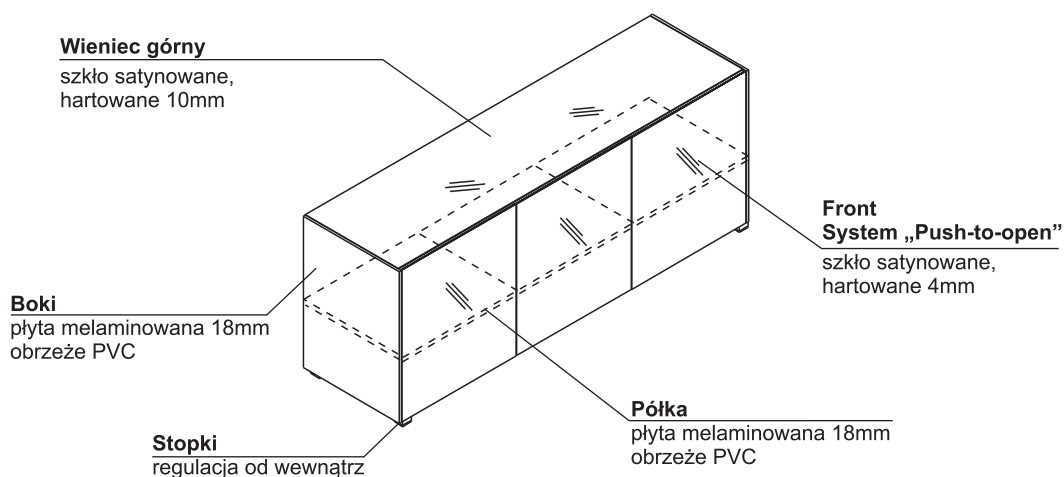

KOMODA ZE SZKŁEM

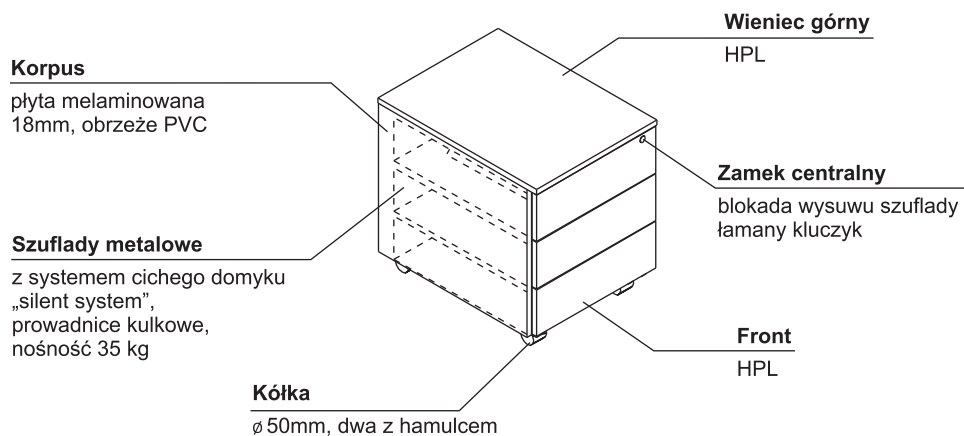

KONTENER SLK13HT

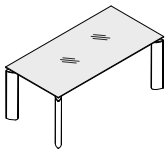
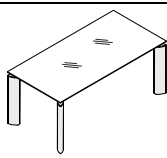
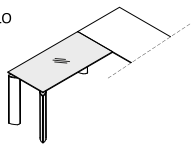
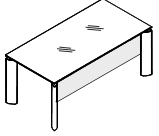

KOLORYSTYKA

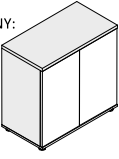
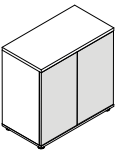
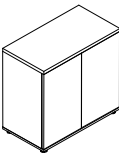
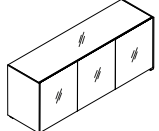
<p>BLAT – SZKŁO</p> 	<p>117 – SZKŁO BIAŁE 116 – SZKŁO CZARNE</p>
<p>STELAŻ</p> 	<p>15 – METAL BIAŁY POŁYSK 08 – METAL CZARNY</p>
<p>PRZYSTAWKA - SZKŁO</p> 	<p>117 – SZKŁO BIAŁE 116 – SZKŁO CZARNE</p>
<p>OSŁONA, STOLIK OKRĄGŁY</p> 	<p>67 – BIAŁY PASTEL 08 – CZARNY</p>
<p>KONTENER SLK13HT</p> 	<p>FRONT WINIEC GÓRNY HPL: 73 - BIAŁY POŁYSK FRONT I WINIEC GÓRNY HPL: 101 - CZARNY POŁYSK KORPUS: 67 - BIAŁY PASTEL KORPUS: 08 - CZARNY</p>
<p>SZAFA Z FRONTEM HPL KORPUS I WINIEC GÓRNY:</p> 	<p>67 – BIAŁY PASTEL</p>
<p>SZAFA Z FRONTEM HPL FRONT:</p> 	<p>72-ZIELONY POŁYSK 82-CZERWONY POŁYSK 73 - BIAŁY POŁYSK 101 - CZARNY POŁYSK 74 - POMARAŃCZOWY POŁYSK</p>
<p>SZAFA Z FRONTEM HPL</p> 	<p>FRONT - HPL: 101-CZARNY POŁYSK WINIEC GÓRNY I KORPUS: 08 - CZARNY</p>
<p>KOMODA ZE SZKŁEM</p> 	<p>FRONT: 117 - SZKŁO BIAŁE FRONT: 116 - SZKŁO CZARNE WINIEC GÓRNY I KORPUS: 67 - BIAŁY PASTEL WINIEC GÓRNY I KORPUS: 08 - CZARNY</p>

WIDOK I RZUT OBIEKTU	WYMIARY (mm)			SYMBOL	CENA NETTO PLN	UWAGI
	Szerokość a / a'	Głębokość b / b'	Wysokość h			

BIURKA Z BLATEM SZKLANYM

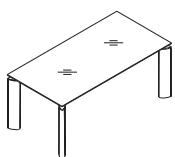
	1600	800	760	AE4S	6 900,-	
	1800	900	760	AE5S	7 300,-	
	2000	900	760	AE6S	7 700,-	

OSŁONY PŁYTOWE DO BIUREK

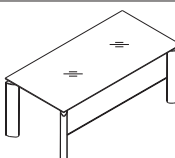
	1400	18	350	AE4B	270,-	
	1600	18	350	AE5B	330,-	
	1800	18	350	AE6B	400,-	

PRZYSTAWKA DO BIURKA Z BLATEM SZKLANYM

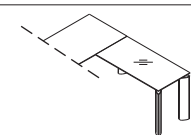
	1200	600	760	AE7S	3 900,-	
---	------	-----	-----	-------------	---------	--

KONTENER MOBILNY Z WIĘNCEM GÓRNYM I FRONTEM HPL

	470	616	580	SLK13HT	1 600,-	- płyta melaminowana Front i wieniec górny HPL
--	-----	-----	-----	----------------	---------	---

KOMODA ZE SZKŁEM

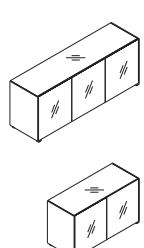
	2000	432	740	AE20S	5 000,-	- wieniec górny i drzwi szkło
	1334	432	740	AE21S	4 100,-	- wieniec górny i drzwi szkło

STÓŁ KONFERENCYJNY Z BLATEM SZKLANYM

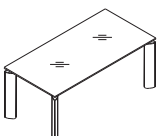



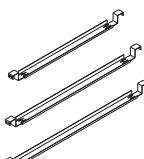

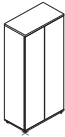

	2200	1100	760	AE11S	8 200,-	
---	------	------	-----	--------------	---------	--

KANAŁY KABLOWE

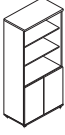



	1496	85	94	EK1200	450,-	- do biurka 1600mm
	1696	85	94	EK1400	465,-	- do biurka 1800mm
	1896	85	94	EK1600	485,-	- do biurka 2000mm

WIDOK I RZUT OBIEKTU	WYMIARY (mm)			SYMBOL	I GRUPA (korpus: 26-alum. sat.)	II GRUPA (szafa cała w kolorze)
	Szerokość a / a'	Głębokość b / b'	Wysokość h			

SZAFY Z FRONTEM HPL

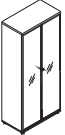
 	802	432	1833	A5104H	-	1 690,-
 	802	432	1833	A5404H	-	1 070,-
 	802	432	1129	A3104H	-	1 135,-
 	802	432	1129	A3404H	-	920,-
 	802	432	777	A2104H	-	835,-

WITRYNY

- drzwi szklane w ramce aluminiowej  	802	432	1833	A5104W	-	1 765,-
- drzwi szklane w ramce aluminiowej - drzwi płytowe: system „Push-to-open” z frontem HPL  	802	432	1833	A5404W	-	1 530,-
- drzwi szklane w ramce aluminiowej  	802	432	1129	A3104W	-	1 135,-



Szafy nie posiadają zamka.

OPIS TECHNICZNY

Zastosowane materiały:

- płyta melaminowana
- profil aluminiowy anodowany, malowany proszkowo

BIURKO, STÓŁ KONFERENCYJNY

Blat

płyta melaminowana 12mm
obrzeże PVC

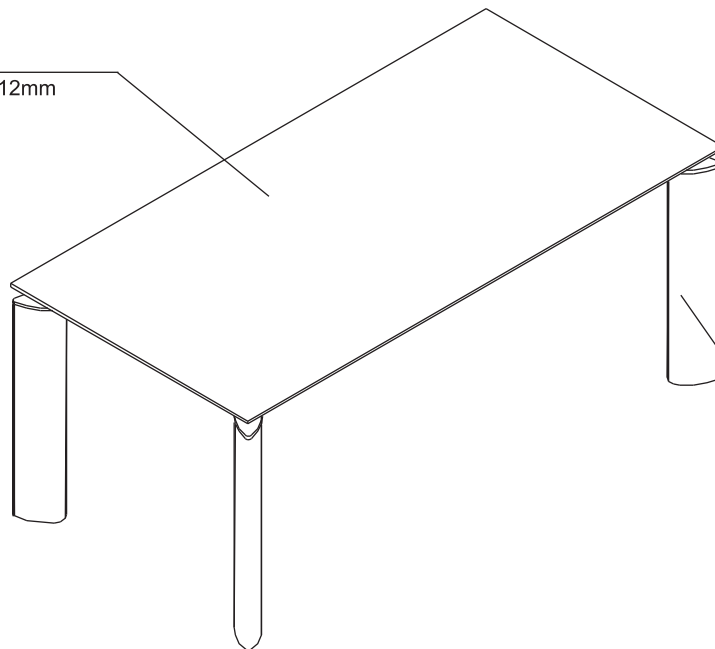

Stelaż

profil aluminiowy

PRYZYSTAWKA

Blat

płyta melaminowana 12mm
obrzeże PVC

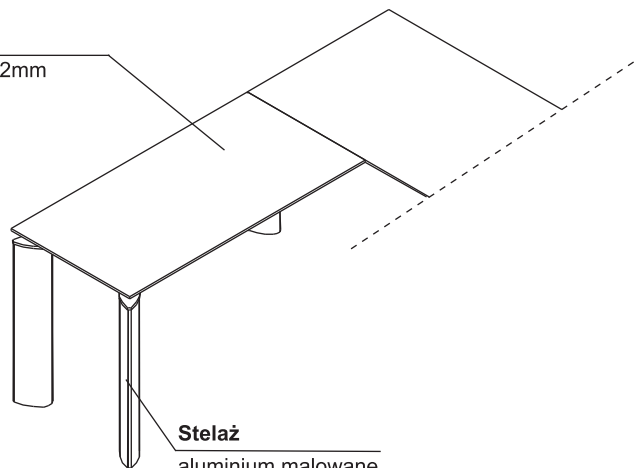

Stelaż

aluminium malowane
proszkowo

BLENDY

Blenda

płyta melaminowana 18mm
obrzeże PVC

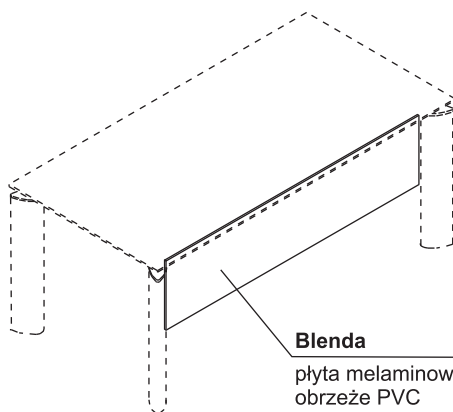

OPIS TECHNICZNY SZAFY

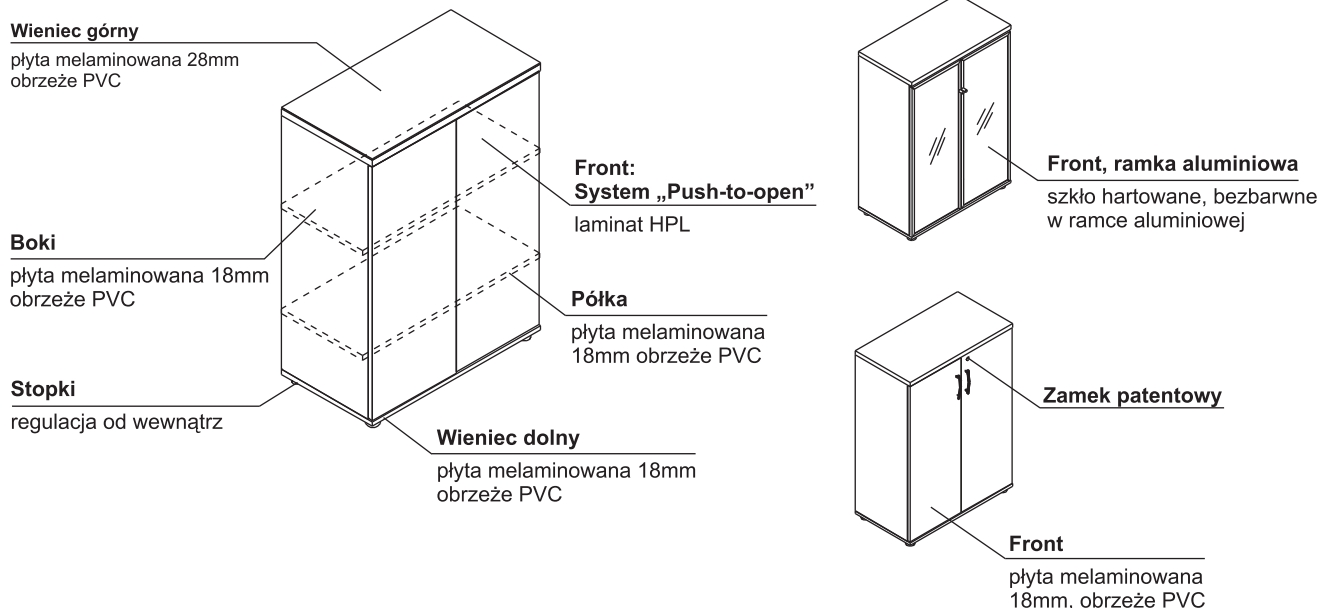

KOMODA ZE SZKŁEM

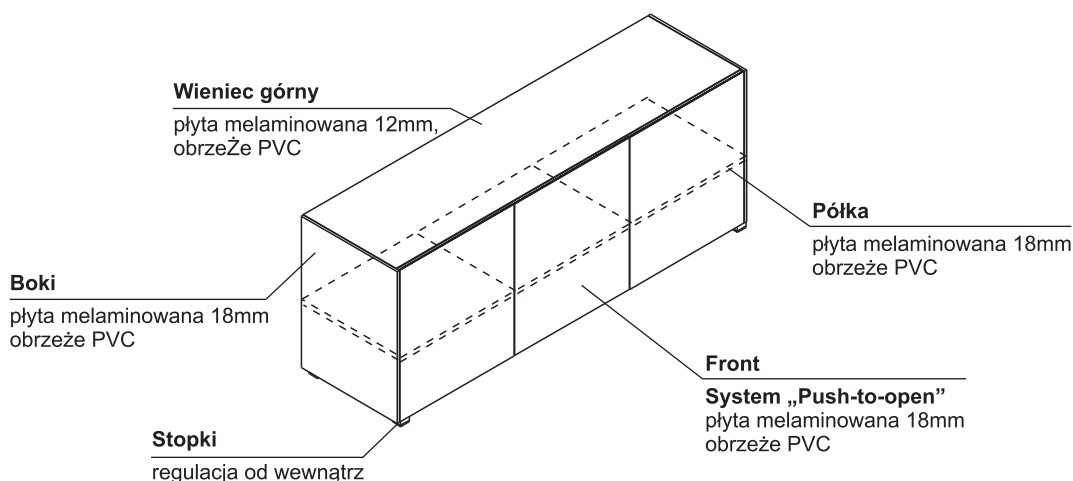

KONTENER SLK13HT

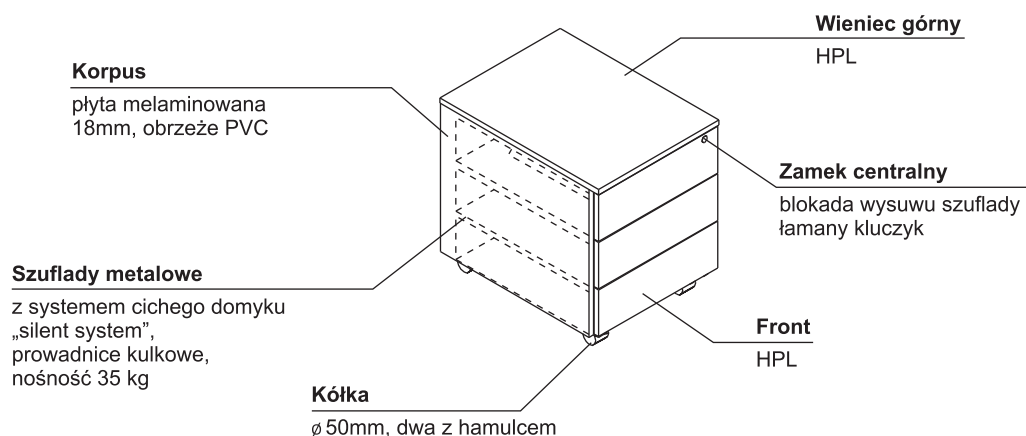

KOLORYSTYKA

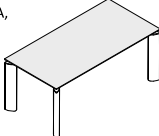
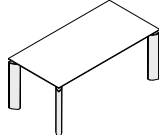
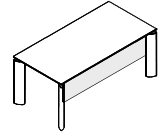
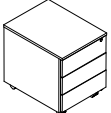
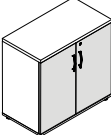
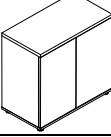
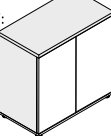
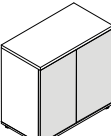
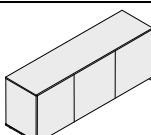
BLAT, PRZYSTAWKA, 	31 – DĄB KANADYJSKI 34 – KASZTAN 67 – BIAŁY PASTEL
STELAŻ 	15 – METAL BIAŁY POŁYSK 08 – METAL CZARNY
OSŁONA 	67 – BIAŁY PASTEL 08 – CZARNY
KONTENER HPL SLK13HT 	FRONT I WIENIEC GÓRNY HPL: 73 - BIAŁY POŁYSK FRONT I WIENIEC GÓRNY HPL: 101 - CZARNY POŁYSK KORPUS: 67 - BIAŁY PASTEL KORPUS: 08 - CZARNY
FRONT, WIENIEC GÓRNY, KORPUS 	31 – DĄB KANADYJSKI 34 – KASZTAN 67 – BIAŁY PASTEL
SZAFA Z FRONTEM HPL 	FRONT - HPL: 101 - CZARNY POŁYSK WIENIEC GÓRNY I KORPUS: 08 - CZARNY
SZAFA Z FRONTEM HPL KORPUS I WIENIEC GÓRNY: 	67 – BIAŁY PASTEL
SZAFA Z FRONTEM HPL FRONT: 	72 – ZIELONY POŁYSK 73 - BIAŁY POŁYSK 74 - POMARAŃCZOWY POŁYSK 82 - CZERWONY POŁYSK 101 - CZARNY POŁYSK
KOMODA AE20 	31 – DĄB KANADYJSKI 34 – KASZTAN

KONFIGURACJA MEDIABOX M01: BIURKO Z BLATEM PŁYTOWYM



- możliwość usytuowania w jednym miejscu (M)
- opcję należy dopisać na końcu symbolu oraz doliczyć wartość mediabox M01 do ceny biurka:
np. AE4M = 3 400zł + 485zł = 3 885zł

KONFIGURACJA MEDIABOX M01: STÓŁ KONFERENCYJNY Z BLATEM PŁYTOWYM

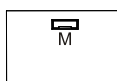

- możliwość usytuowania w jednym miejscu (M)
- opcję należy dopisać na końcu symbolu oraz doliczyć wartość mediabox M01 do ceny biurka:
np. AE11M = 4 500zł + 485zł = 4 985zł

WIDOK I RZUT OBIEKTU	WYMIARY (mm)			SYMBOL	CENA NETTO PLN	UWAGI
	Szerokość a / a'	Głębokość b / b'	Wysokość h			

BIURKA Z BLATEM PŁYTOWYM

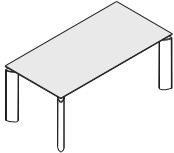
	1600	800	760	AE4	3 400,-	
	1800	900	760	AE5	3 800,-	
	2000	900	760	AE6	4 200,-	

OSŁONY PŁYTOWE DO BIUREK

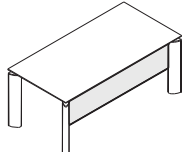
	1400	18	350	AE4B	270,-	
	1600	18	350	AE5B	330,-	
	1800	18	350	AE6B	400,-	

PRZYSTAWKA DO BIURKA Z BLATEM PŁYTOWYM

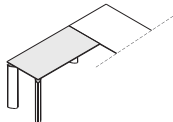
	1200	600	760	AE7	1 900,-	
---	------	-----	-----	------------	---------	--

KONTENER MOBILNY Z WIĘNCEM GÓRNYM I FRONTEM HPL

	470	616	580	SLK13HT	1 600,-	- płyta melaminowana Front i wieńiec górny HPL
--	-----	-----	-----	----------------	---------	---

KOMODA

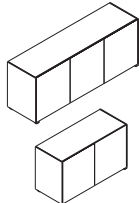
	2000	432	740	AE20	3 000,-	
	1334	432	740	AE21	2 500,-	

STÓŁ KONFERENCYJNY Z BLATEM PŁYTOWYM

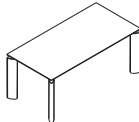
	2200	1100	760	AE11	4 500,-	
---	------	------	-----	-------------	---------	--

ELEMENTY DODATKOWE





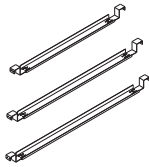

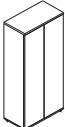

	300	110	110	M01	485,-	- 4 x 230V - 2 x RJ45 104-szary struktura - wyłącznie do blatów płytowych
---	-----	-----	-----	------------	-------	--

KANAŁY KABLOWE

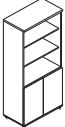



	1496	85	94	EK1200	450,-	- do biurka 1600mm
	1696	85	94	EK1400	465,-	- do biurka 1800mm
	1896	85	94	EK1600	485,-	- do biurka 2000mm

WIDOK I RZUT OBIEKTU	WYMIARY (mm)			SYMBOL	I GRUPA (korpus: 26-alum. sat.)	II GRUPA (szafa cała w kolorze)
	Szerokość a / a'	Głębokość b / b'	Wysokość h			



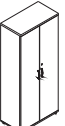
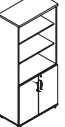

SZAFY Z FRONTEM HPL

 	802	432	1833	A5104H	-	1 690,-
 	802	432	1833	A5404H	-	1 070,-
 	802	432	1129	A3104H	-	1 135,-
 	802	432	1129	A3404H	-	920,-
 	802	432	777	A2104H	-	835,-

SZAFY

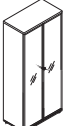
	802	432	1833	A5104	-	1 065,-
	802	432	1833	A5404	-	965,-
	802	432	1129	A3104	-	780,-
	802	432	1129	A3504	-	540,-
	802	432	777	A2104	-	620,-

WITRYNY

- drzwi szklane w ramce aluminiowej  	802	432	1833	A5104W	-	1 765,-
- drzwi szklane w ramce aluminiowej - drzwi płytowe: system „Push-to-open” z frontem HPL  	802	432	1833	A5404W	-	1 530,-
- drzwi szklane w ramce aluminiowej  	802	432	1129	A3104W	-	1 135,-

 Szafy nie posiadają zamka.

OPIS TECHNICZNY

BIURKO, STÓŁ

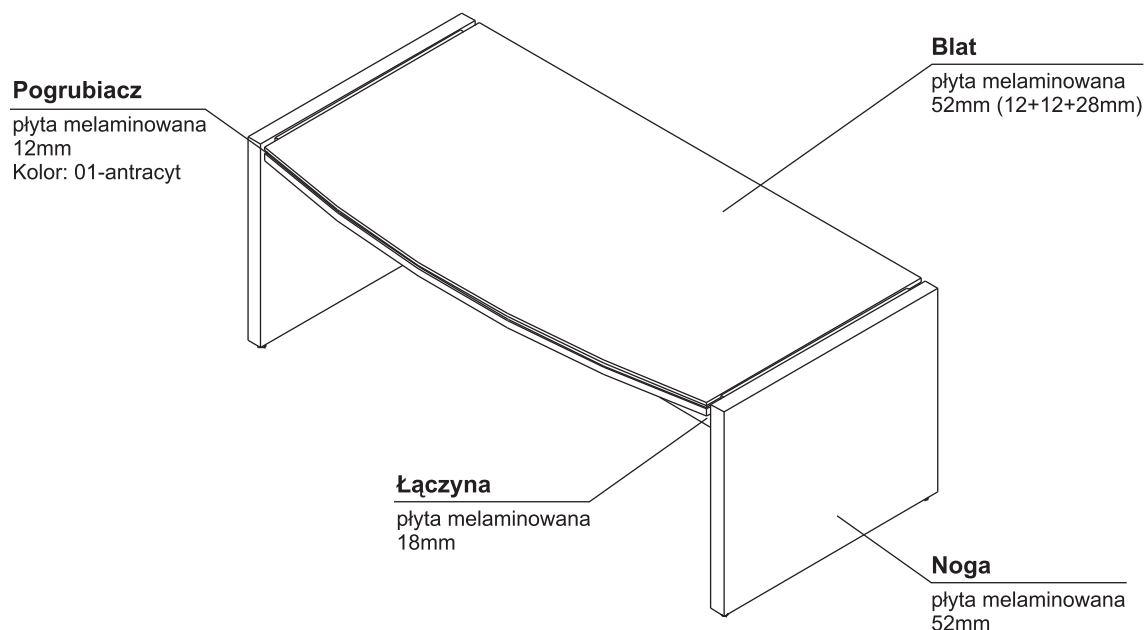

KONFIGURACJA MEDIAPORTU



* Istnieje możliwość zamówienia stołów konferencyjnych i biur z listwami zasilającymi „Mediaport”:

- listwa S91E: usytuowanie A, B, lub C (2 szt.)

- listwa S92E: usytuowanie G, H lub K (2 szt.)

Wybraną opcję należy dopisać na końcu symbolu wyrobu oraz doliczyć wartość Mediaportu do ceny biurka:

np. X01A = 2 095zł + 1 550zł = 3 645zł

X05K = 2 250zł + 2x 2 130zł = 6 510zł

X01C = 2 095zł + 2x 1 550zł = 5 195zł

X05G = 2 250zł + 2 130zł = 4 380zł

KONTENER

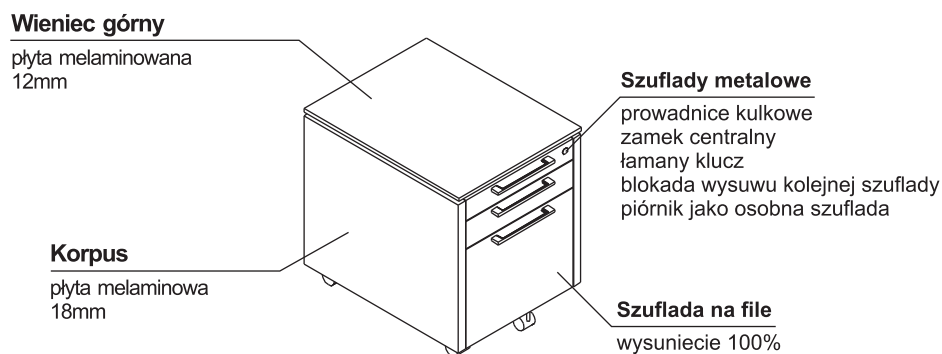

OPIS TECHNICZNY

SZAFKA

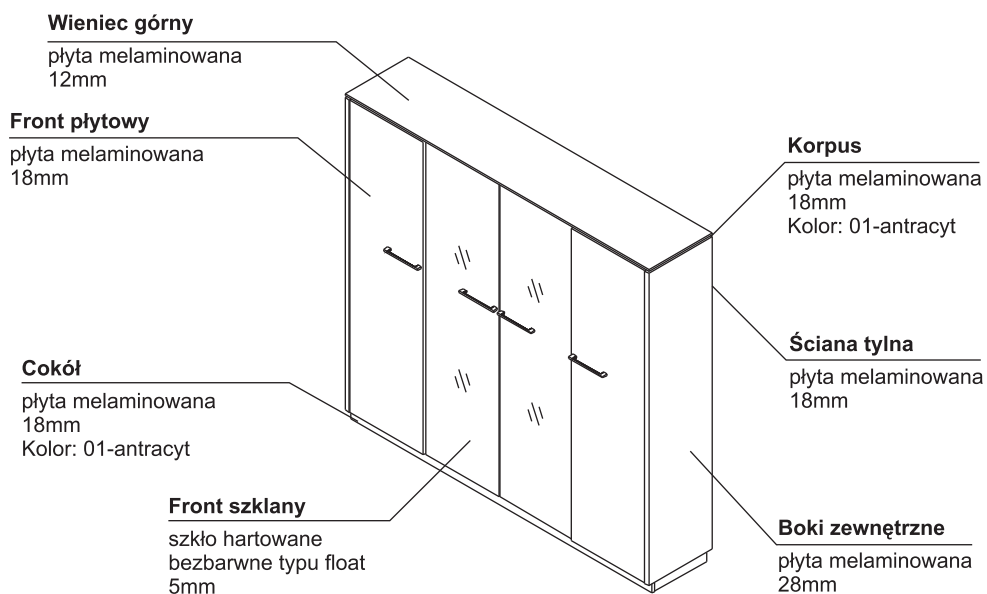

* Szafy nie posiadają zamka. Istnieje możliwość montażu zamków dwupunktowych baswilowych tylko do drzwi płytowych za dopłatą 88zł/szt. Każde skrzydło musi posiadać osobny zamek. Na końcu symbolu wyrobu należy dopisać literę „Z” np. X51Z.

KOLORYSTYKA

BLAT, BLENDY, NOGI PŁYTOWE		31-DĄB KANADYJSKI 34-KASZTAN 106-ORZECH NIZINNY
POGRUBIACZ		01-ANTRACYT
WIENIEC GÓRNY, FRONT		31-DĄB KANADYJSKI 34-KASZTAN 106-ORZECH NIZINNY
KORPUS		01-ANTRACYT
WIENIEC GÓRNY, FRONT		31-DĄB KANADYJSKI 34-KASZTAN 106-ORZECH NIZINNY
KORPUS (WNĘTRZE), COKÓŁ		01-ANTRACYT
MEDIAPORT S91E S92E		09-ALUMINIUM

WIDOK I RZUT OBIEKTU	WYMIARY			SYMBOL	CENA NETTO PLN	UWAGI
	Szerokość a / a'	Głębokość b / b'	Wysokość h			

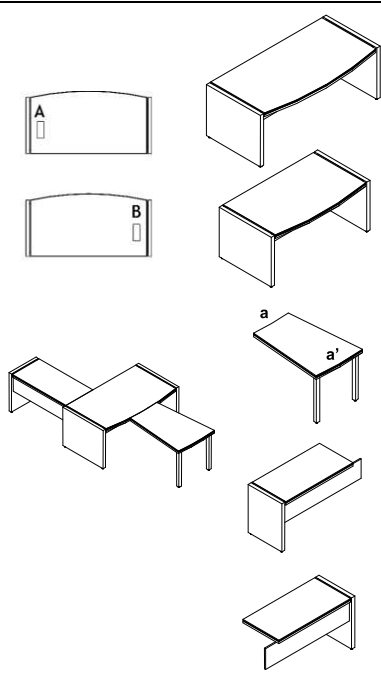

BIURKA I PRZYSTAWKI

	2000	1000	760	X01	2 095,-	- usytuowanie media portu A lub B
	1700	970	760	X02	2 010,-	
	600/800	1200	760	X14	1 375,-	- przystawka przednia, konferencyjna
	600	1270	760	X15	1 210,-	- przystawka boczna, prawa
	600	1270	760	X16	1 210,-	- przystawka boczna, lewa

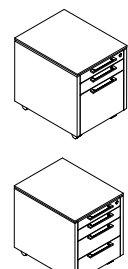
KONTENERY

	484	635	602	XKR12	1 460,-	- szuflada na file
	484	635	602	XKR13	1 590,-	

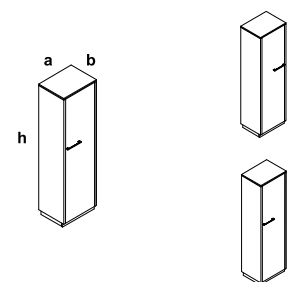
SZAFY 5 OH

	544	421	1871	X56	1 755,-	- drzwi lewe 
	544	421	1871	X57	1 755,-	- drzwi prawe 

WIDOK I RZUT OBIEKTU	WYMIARY			SYMBOL	CENA NETTO PLN	UWAGI
	Szerokość a / a'	Głębokość b / b'	Wysokość h			

SZAFY 5 OH







	544	421	1871	X59	1 540,-	
	1032	421	1871	X51	2 530,-	
	1032	421	1871	X52	2 390,-	- szafa ubraniowo - aktowa z wieszakiem wysuwanym
	1032	421	1871	X55	3 510,-	- drzwi szklane, szkło bezbarwne hartowane
	1520	421	1871	X5679	3 620,-	
	2008	421	1871	X5567	5 590,-	- drzwi szklane, szkło bezbarwne hartowane
	2496	421	1871	X5119	5 175,-	
	2496	421	1871	X5129	5 032,-	- zawiera część ubraniową

SZAFY 3 OH

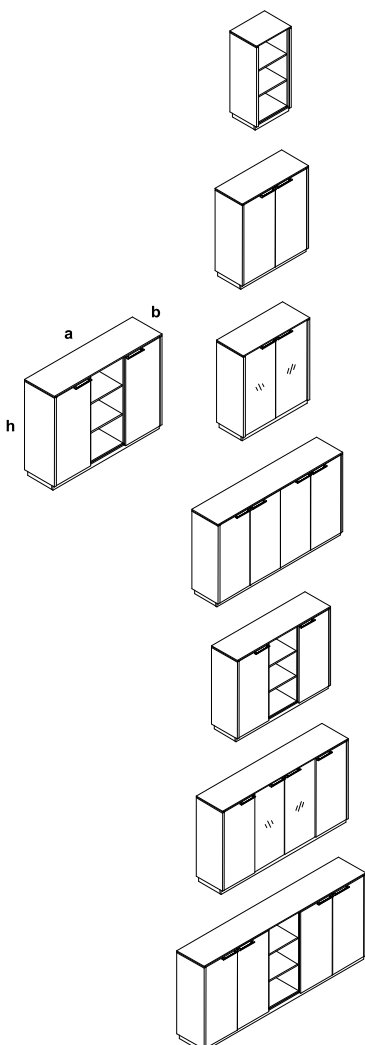



	544	421	1167	X36	1 350,-	- drzwi lewe
	544	421	1167	X37	1 350,-	- drzwi prawe

WIDOK I RZUT OBIEKTU	WYMIARY			SYMBOL	CENA NETTO PLN	UWAGI
	Szerokość a / a'	Głębokość b / b'	Wysokość h			

SZAFY 3 OH

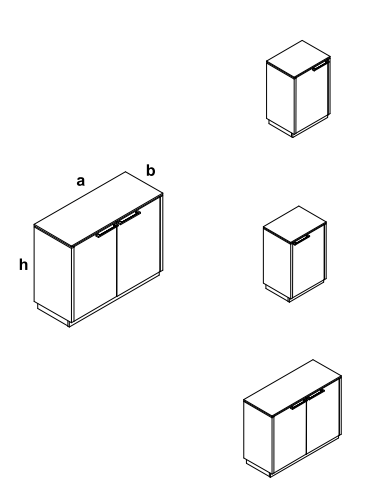

	544	421	1167	X39	1 195,-	
	1032	421	1167	X31	1 895,-	
	1032	421	1167	X35	2 555,-	- drzwi szklane, szkło bezbarwne hartowane 
	2008	421	1167	X311	3 205,-	
	1520	421	1167	X3679	2 720,-	
	2008	421	1167	X3567	4 080,-	- drzwi szklane, szkło bezbarwne hartowane 
	2496	421	1167	X3119	3 815,-	

SZAFY 2 OH

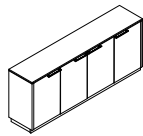

	544	421	815	X26	1 110,-	
	544	421	815	X27	1 110,-	
	1032	421	815	X21	1 525,-	

WIDOK I RZUT OBIEKTU	WYMIARY			SYMBOL	CENA NETTO PLN	UWAGI
	Szerokość a / a'	Głębokość b / b'	Wysokość h			

SZAFY 2 OH

	2008	421	815	X2167	2 820,-	
---	------	-----	-----	--------------	---------	---

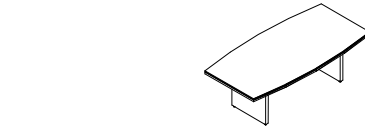
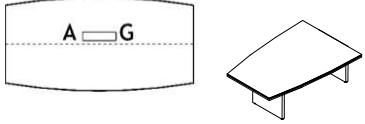
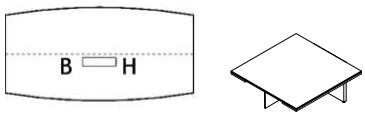
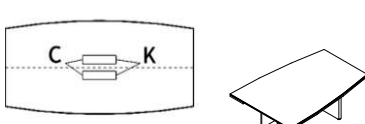
STOŁY I STOLIKI

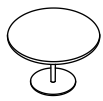
	2400	1200	760	X05	2 250,-	- usytuowanie media portu A,C (2 szt.) lub G,K (2 szt.)
	2000	1400	760	X06	2 095,-	- element początkowy stołu konferencyjnego - usytuowanie media portu A,B, C (2 szt.) lub G,H,K (2 szt.)
	1400	1400	760	X07	1 340,-	- element środkowy stołu konferencyjnego - usytuowanie media portu A,B, C (2 szt.) lub G,H,K (2 szt.)
	2000	1400	760	X08	1 895,-	- element końcowy stołu konferencyjnego - usytuowanie media portu A,B, C (2 szt.) lub G,H,K (2 szt.)
	∅ 800	-	550	X19	1 190,-	
	∅ 800	-	760	X22	1 445,-	
	∅ 1200	-	754	X120	1 380,-	

STOŁY I STOLIKI – DODATKI

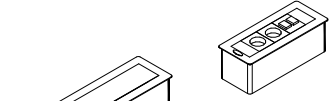
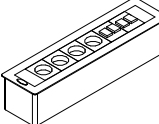
	267	110	93	S91E	1 550,-	- cena podlega rabatowaniu - 2 x 230V, gniazdo zasilające - 2 x RJ45, gniazdo sieciowe
	426	110	93	S92E	2 130,-	- cena podlega rabatowaniu - 4 x 230V, gniazdo zasilające - 4 x RJ45, gniazdo sieciowe

ROZWIĄZANIA POŁOŻENIA MEDIA PORTÓW

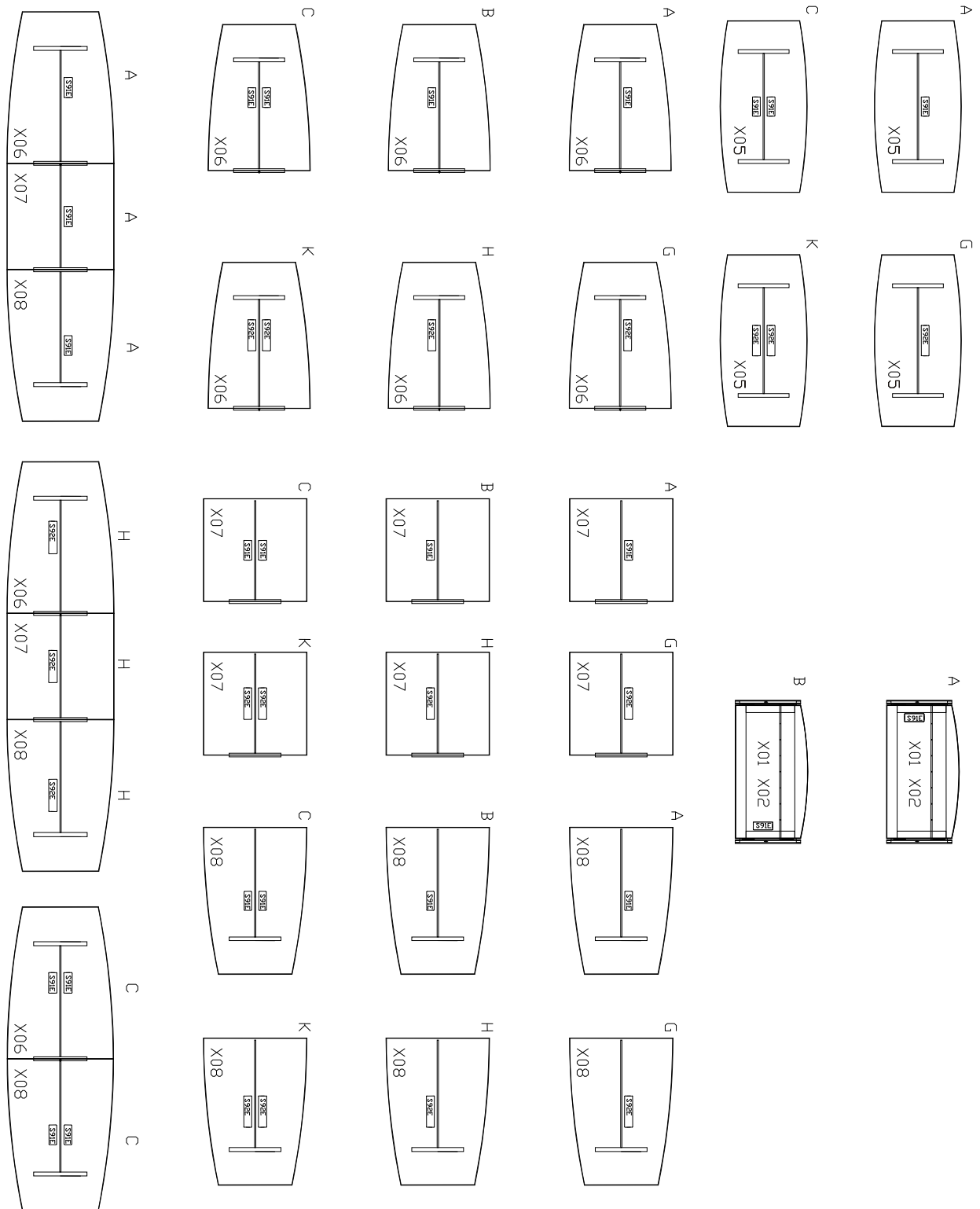

OPIS TECHNICZNY

BIURKO

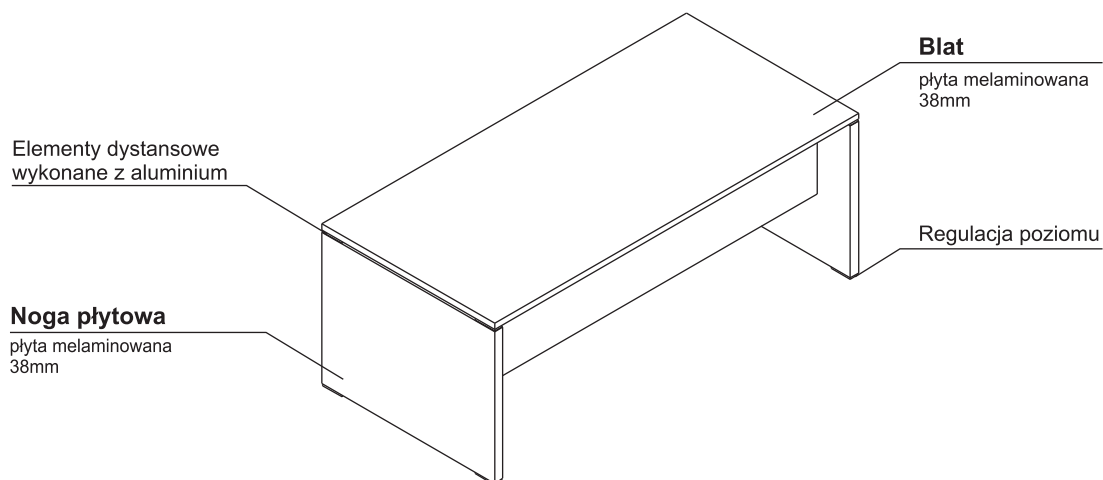

KOMODA

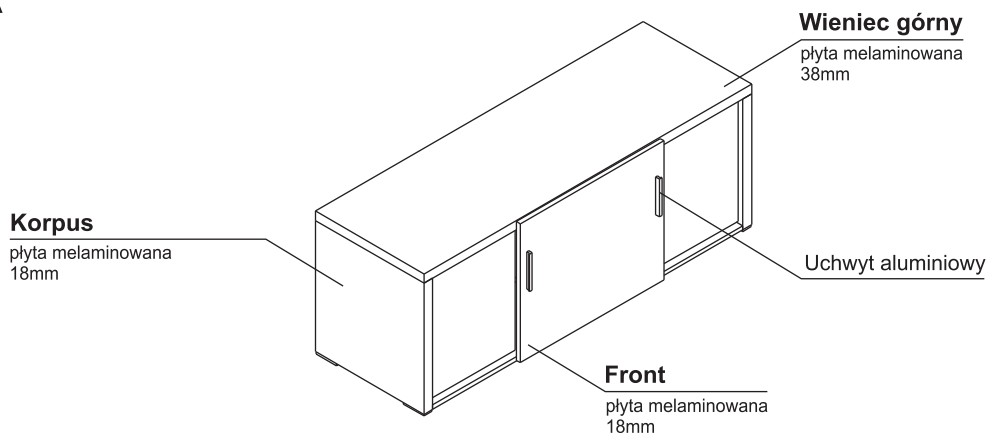

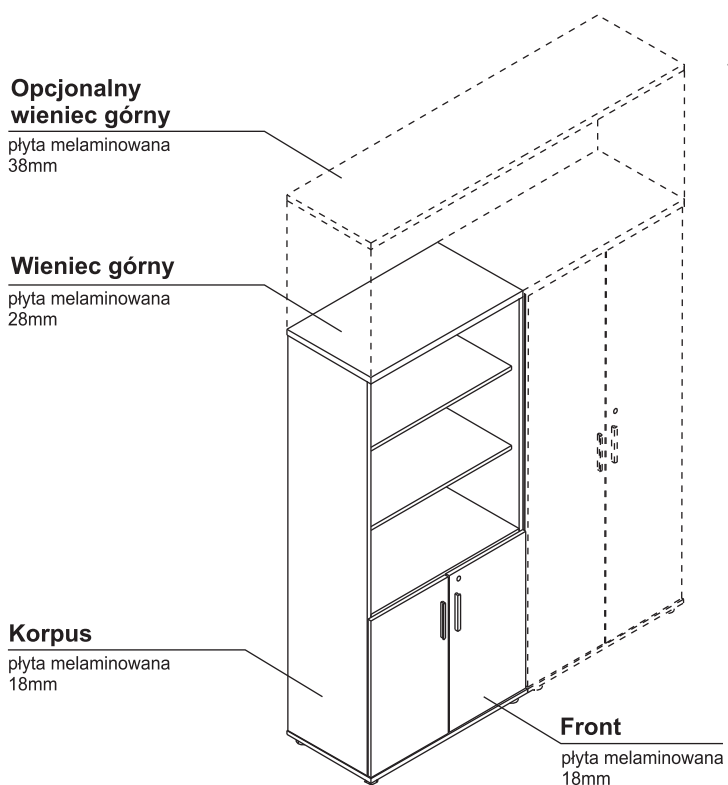

SZAFA I KONTENER MOBILNY

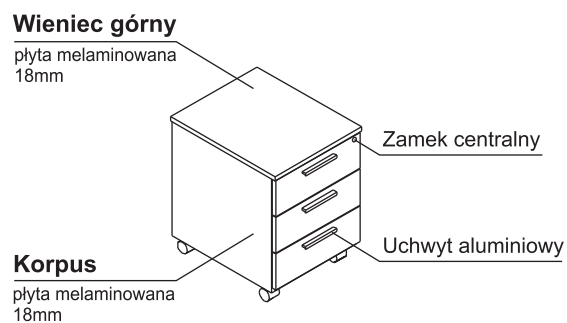

Opcjonalny wieniec górny nakładany na 1, 2 lub 3 zestawione szafy o szerokości 800mm.

Opcjonalny wieniec górny zastępuje standardowy.

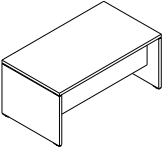
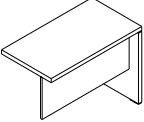
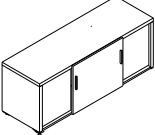
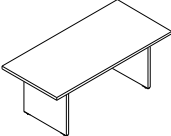

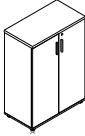
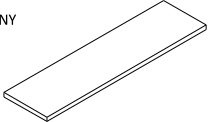
KOLORYSTYKA	
<p>BIURKO</p> 	<p>34-KASZTAN 106-ORZECH NIZINNY</p>
<p>PRZYSTAWKA</p> 	<p>34-KASZTAN 106-ORZECH NIZINNY</p>
<p>KOMODA</p> 	<p>34-KASZTAN 106-ORZECH NIZINNY</p>
<p>STÓŁ</p> 	<p>34-KASZTAN 106-ORZECH NIZINNY</p>
<p>KONTENER</p> 	<p>34-KASZTAN 106-ORZECH NIZINNY</p>
<p>SZAFA</p> 	<p>34-KASZTAN 106-ORZECH NIZINNY</p>
<p>OPCJONALNY WIENIEC GÓRNY</p> 	<p>34-KASZTAN 106-ORZECH NIZINNY</p>

WIDOK I RZUT OBIEKTU	WYMIARY (mm)			SYMBOL	CENA NETTO PLN	UWAGI
	Szerokość a/a'	Głębokość b/b'	Wysokość h			

BIURKA, PRZYSTAWKA

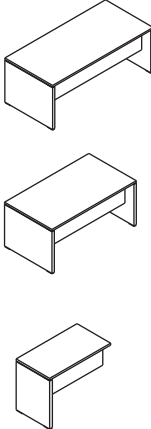
	1900	900	740	Q19	1 320,-	
	1600	900	740	Q16	1 270,-	
	1000	550	740	Q10	490,-	- uniwersalne: lewe, prawe

BIURKO Z SZAFKĄ

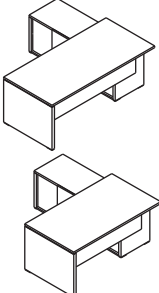
	1900/2164	900/1800	740	QU19	2 460,-	
	1600/1864	900/1800	740	QU16	2 410,-	

USTAWIENIA

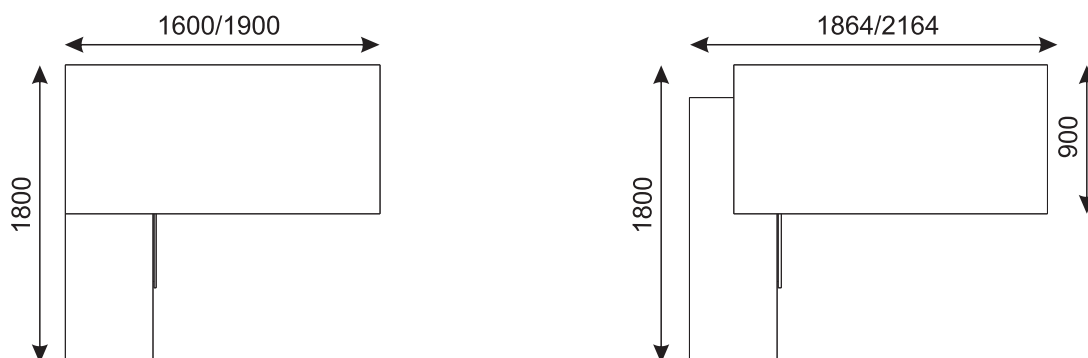

KOMODA

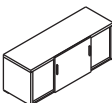
	1600	550	600	QR16	1 290,-	
---	------	-----	-----	-------------	---------	--

KONTENER

	434	520	580	Q13	450,-	
---	-----	-----	-----	------------	-------	--

WIDOK I RZUT OBIEKTU	WYMIARY (mm)			SYMBOL	CENA NETTO PLN	UWAGI
	Szerokość a/a'	Głębokość b/b'	Wysokość h			

STOŁY I STOLIKI

	1900	900	740	QS19	1 350,-	
	800	800	550	QSL08	650,-	
	800	800	740	QS08	700,-	

SZAFY

	1400	431	1280	Q315	2 000,-	szafa cała w kolorze
	802	432	1833	Q51	1 050,-	
	802	432	1833	Q54	920,-	
	802	432	1129	Q31	755,-	
	802	432	1129	Q35	480,-	
	800	20	1050	KS300	685,-	- kpl. drzwi szklanych 3 OH z ramka aluminiową - szkło mleczne

OPCJONALNE TOPY DO SZAF

	806	432	38	QT08	260,-	
	1608	432	38	QT16	290,-	
	2410	432	38	QT24	320,-	

PL: Ogólna charakterystyka produktu:

Melamina: klasa E1

Płyta wiórowa melaminowana, spełnia normę NFB 54.113

Gęstość:

-690-750 kg/m – 12 mm grubości, krawędzie pokryte 2 mm PVC

-650-690 kg/m – 18 mm grubości, krawędzie pokryte 2 mm PVC

-610-630 kg/m – 28 mm grubości, krawędzie pokryte 2 mm PVC

-610-630 kg/m – 36 mm grubości, krawędzie pokryte 2 mm PVC

Maksymalne dopuszczalne obciążenie dla półek i szuflad:

1. Grubość 18 mm – 70kg/m² przy masie równomiernie rozłożonej na powierzchni półki
2. Prowadnice kulkowe – 35 kg

Wszystkie użyte materiały są przyjazne dla środowiska, łatwo je oddzielić i przekazać do recyklingu.

